



OLYMPIC WINTER SPORT

THE RULES OF CURLING and Rules of Competition

October 2015

THE SPIRIT OF CURLING

Curling is a game of skill and of tradition. A shot well executed is a delight to see and it is also a fine thing to observe the time-honoured traditions of curling being applied in the true spirit of the game. Curlers play to win, but never to humble their opponents. A true curler never attempts to distract opponents, nor to prevent them from playing their best, and would prefer to lose rather than to win unfairly.

Curlers never knowingly break a rule of the game, nor disrespect any of its traditions. Should they become aware that this has been done inadvertently, they will be the first to divulge the breach.

While the main object of the game of curling is to determine the relative skill of the players, the spirit of curling demands good sportsmanship, kindly feeling and honourable conduct.

This spirit should influence both the interpretation and the application of the rules of the game and also the conduct of all participants on and off the ice.

REVIEW PROCESS

The Rules of Curling and the Rules of Competition will be reviewed by the World Curling Federation (WCF) Competitions & Rules Commission on an annual basis. Member Associations may submit in writing suggestions for this review to the Secretariat by 15 May. The proposals will be discussed at the WCF Annual Congress and then voted upon at the WCF Annual General Assembly.

WCF MISSION STATEMENT

To be the world's favourite Olympic / Paralympic Winter team sport.

WCF SECRETARIAT

3 Atholl Crescent
Perth PH1 5NG, Scotland
Tel: +44 1738 451 630 Fax: +44 1738 451 641
info@worldcurling.org www.worldcurling.org

TABLE OF CONTENTS

	Page
The Spirit of Curling / Review Process / WCF Mission Statement	1
Table of Contents	2
The Rules of Curling:	
R1. Sheet	3
R2. Stones	5
R3. Teams	6
R4. Position of Players	8
R5. Delivery	9
R6. Free Guard Zone (FGZ)	11
R7. Sweeping	11
R8. Touched Moving Stones	12
R9. Displaced Stationary Stones	14
R10. Equipment	15
R11. Scoring	17
R12. Interrupted Games	19
R13. Wheelchair Curling	19
R14. Mixed Curling	20
R15. Mixed Doubles Curling	21
R16. Prohibited Substances	26
R17. Inappropriate Behaviour	26
Rules of Competition:	
C1. General	27
C2. Participating Teams	28
C3. Uniforms / Equipment	30
C4. Pre-Game Practice	31
C5. Length of Games	32
C6. Game Timing	32
C7. Team Time-Outs / Technical Time-Outs	35
C8. Stone Assignment / LSD	36
C9. Team Ranking Procedure / DSC	39
C10. Umpires	40
Competitions – the Playdown Systems	42
Qualification - World Championships Men & Women	46
Qualification - World Junior Championships (WJCC)	47
World Seniors (WSCC), World Mixed Doubles (WMDCC) & World Mixed Curling Championship (WMxCC)	47
Pacific-Asia Curling Championships (PACC)	49
European Curling Championships (ECC)	50
Qualification System – the Americas Zone	52
Minimum Standards, Eligibility	55
Tie-breakers for four Qualifiers	57
Tie-breakers for Relegation	61
Tie-breakers for Qualifiers and Relegation	62
Play-off Systems	64
Quarter-Finals Play-off System	65
Dress Code	66
Glossary of Terms	67

THE RULES OF CURLING

These rules apply to any game or competition to which they are made applicable by the curling organisation having jurisdiction.

R1. SHEET

- (a) The length of the sheet from the inside edges of the back boards is 45.720 metres (150 feet). The width of the sheet from the inside edges of the side lines is a maximum of 5.000 m. (16 ft. 5 inches). This area is delineated by lines drawn, or by dividers placed on the perimeter. If the size of an existing facility will not permit these measurements, then the length may be reduced to a minimum of 44.501 m. (146 ft.), and the width to a minimum of 4.420 m. (14 ft. 6 in.).
- (b) At each end of the sheet there are clearly visible parallel lines in the ice from side line to side line as follows:
 - (i) the tee line, 1.27 cm. (1/2 in.) maximum width, placed so that the centre of the line is 17.375 m. (57 ft.) from the middle of the sheet.
 - (ii) the back line, 1.27 cm. (1/2 in.) maximum width, placed so that the outside edge is 1.829 m. (6 ft.) from the centre of the tee line.
 - (iii) the hog line, 10.16 cm. (4 in.) in width, placed so that the inside edge is 6.401 m. (21 ft.) from the centre of the tee line.
 - (iv) the centre line, 1.27 cm. (1/2 in.) maximum width, joins the midpoints of the tee lines and extends 3.658 m. (12 ft.) beyond the centre of each tee line.
 - (v) the hack line, 0.457 m. (1 ft. 6 in.) in length and 1.27 cm. (1/2 in.) maximum width, is placed parallel to the tee line, at each end of the centre line.
 - (vi) the courtesy line, 15.24 cm. (6 in.) in length and 1.27 cm. (1/2 in.) maximum width, is placed 1.219 m. (4 ft.) outside and parallel to the hog lines, on each side of the sheet.

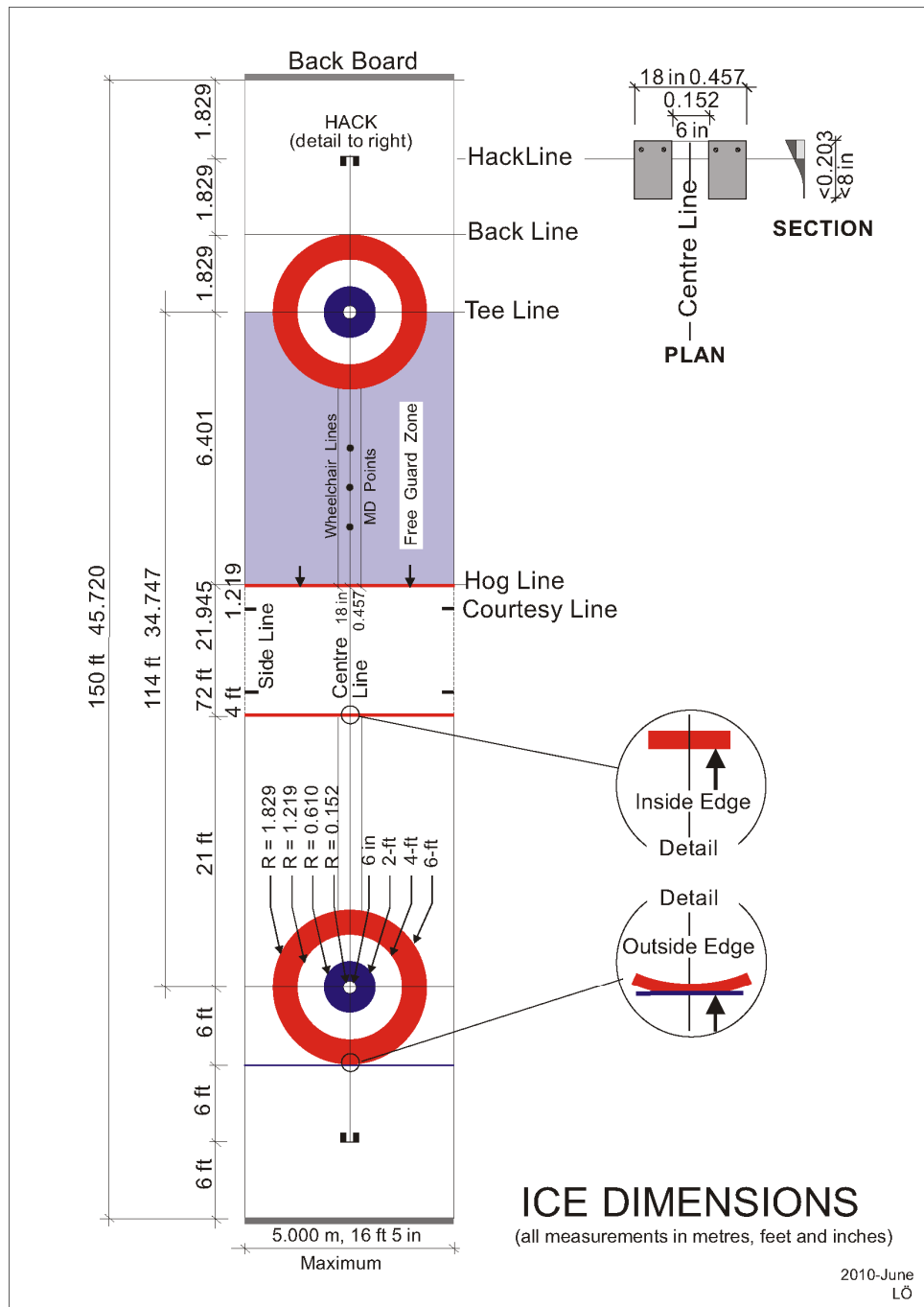

- (c) For wheelchair events, at each end of the sheet, 2 thin (i.e. - wool) wheelchair lines are placed parallel to and on opposite sides of the centre line, extending from the hog line to the outermost edge of the nearest circle, with the outside edge of each line being 0.457 m. (18 in.) from the centre line.
- (d) A centre hole (tee) is placed at the intersection of each tee line and centre line. With the tee as centre, there are four concentric circles placed at each end of the sheet, with the outer edge of the outer circle having a radius of 1.829 m. (6 ft.), the next circle a radius of 1.219 m. (4 ft.), the next circle a radius of 0.610 m. (2 ft.), and the innermost circle having a minimum radius of 15.24 cm. (6 in.).
- (e) Two hacks are placed on the hack line, on opposite sides of the centre line, with the inside edge of each hack 7.62 cm. (3 in.) from the midpoint of the centre line. The width of each hack shall not exceed 15.24 cm. (6 in.). The hack is attached to suitable material, and the inside edge of that material is placed on the inside edge of the hack line so that the hack does not extend more than 20.32 cm. (8 in.) in front of the hack line. If the hack is recessed into the ice, this is not to be more than 3.81 cm. (1.5 in.) in depth.

R2. STONES

- (a) A curling stone is of circular shape, having a circumference no greater than 91.44 cm. (36 in.), a height no less than 11.43 cm. (4.5 in.), and a weight, including handle and bolt, no greater than 19.96 kg. (44 lbs.) and no less than 17.24 kg. (38 lbs.).
- (b) Each team uses a set of eight stones having the same handle colour and individually identified by visible markings. If a stone is damaged and becomes unsuitable for play, a replacement stone is used. If a replacement stone is not available, a stone previously delivered in the end is redelivered.

- (c) If a stone is broken in play, the teams use the “Spirit of Curling” to decide where the stone(s) should be placed. If agreement cannot be reached, the end will be replayed.
- (d) If a stone rolls over while in motion, or comes to rest on its side or top, it is removed from play immediately.
- (e) Should a handle completely separate from a stone during delivery, the delivering player has the option of either allowing the play to stand, or of redelivering the stone after any displaced stones have been replaced to their positions prior to the incident taking place.
- (f) A stone that does not come to rest completely beyond the inside edge of the hog line at the playing end is removed from play immediately, except when it strikes another stone, in which case it remains in play.
- (g) A stone that completely crosses the outside edge of the back line at the playing end is removed from play immediately.
- (h) A stone that touches a divider or a side line is removed from play immediately and is prevented from entering adjacent sheets.
- (i) A stone may be measured only visually until the last stone of the end has come to rest, except to determine if a stone is in play, or, prior to playing the second, third, or fourth stone of an end, to determine if a stone is in the Free Guard Zone.
- (j) Teams are not to make alterations to, nor place any object on or over, their game stones.

R3. TEAMS

- (a) A team is composed of four players. Each player delivers two stones, in consecutive order in each end, while alternating with an opponent.

- (b) A team declares its delivery rotation, and the skip and vice-skip positions, prior to the start of a game and maintains that rotation and those positions throughout that game subject to (d) (ii). A team that deliberately changes its delivery rotation during a game will forfeit the game, unless it was done when bringing in an alternate player.
- (c) If a player is missing at the start of a game, the team may either:
 - (i) start the game with three players, the first two players delivering three stones each, and the third player delivering two stones, in which case the missing player may enter the game in the declared delivery rotation and position at the start of an end; or
 - (ii) start the game using a qualified alternate.
- (d) Where a player is unable to continue to play in a game, the team may either:
 - (i) continue play with the remaining three players, in which case the player who left the game may re-enter at any time provided that the returning player’s two stones are delivered within the team’s declared delivery rotation in that end. A player may leave and return to a game only one time in any game; or
 - (ii) bring in a qualified alternate at the beginning of an end, in which case the delivery rotation and the skip and vice-skip positions may be changed (the revised rotation of play applying for the remainder of that game), and the replaced player may not re-enter the game.
- (e) A team may not play with fewer than three players, all players delivering all their allocated stones in each end.
- (f) In competitions where alternates are allowed, only one alternate can be registered and used in that competition. If there is a violation, the offending team will forfeit the game.
- (g) If a player delivers the first allocated stone of an end and is unable to deliver the second allocated stone, the following is the procedure for the remainder of that end. If the player is the:

- (i) first player, the second player delivers the stone
 - (ii) second player, the first player delivers the stone
 - (iii) third player, the second player delivers the stone
 - (iv) fourth player, the third player delivers the stone
- (h) If a player whose turn it is to deliver is unable to deliver both of the allocated stones during an end, the following is the procedure for the remainder of that end. If the player is the:
- (i) first player, the second player delivers three stones, then the third player delivers three stones, then the fourth player delivers the last two stones
 - (ii) second player, the first player delivers three stones, then the third player delivers three stones, then the fourth player delivers the last two stones
 - (iii) third player, the first player delivers the first stone of the third player, then the second player delivers the second stone of the third player, then the fourth player delivers the last two stones
 - (iv) fourth player, the second player delivers the first stone of the fourth player, then the third player delivers the second stone of the fourth player.

R4. POSITION OF PLAYERS

- (a) Non-Delivering Team:
- (i) During the process of delivery the players take stationary positions along the side lines between the courtesy lines. However:
 - 1) the skip and/or vice-skip may take stationary positions behind the back line at the playing end, but must not interfere with the choice of place of the skip or vice-skip of the delivering team.
 - 2) the player who is to deliver next may take a stationary position to the side of the sheet, behind the hacks, at the delivery end.

- (ii) The non-delivering team players must not take any position, nor cause any motion, which could obstruct, interfere with, distract or intimidate the delivering team. If such an action occurs, or an external force distracts a player during delivery, that player has the option of allowing the play to stand, or of redelivering the stone after all displaced stones have been replaced to their positions prior to the violation taking place.

(b) Delivering Team:

- (i) The skip, or the vice-skip when it is the skip's turn to deliver, or when the skip is not on the ice, is in charge of the house.
- (ii) The player in charge of the house is positioned inside the hog line, with at least one foot/wheel on the ice surface of the playing end of the team's sheet, while the team is in the process of delivery.
- (iii) The players who are not in charge of the house or delivering a stone take positions to sweep.
- (iv) Any improper position of players will result in the delivered stone being removed from play, and any displaced stones shall be replaced, by the non-offending team, to their positions prior to the violation taking place.

R5. DELIVERY

- (a) Unless predetermined, or decided by the Last Stone Draw (LSD), the teams opposing each other in a game shall use a coin toss to determine which team delivers the first stone in the first end. This order of play shall be maintained until one team scores, after which the team that most recently scored delivers the first stone in any subsequent end.
- (b) Unless predetermined, the team playing the first stone of the first end has the choice of stone handle colour for that game.

- (c) Right-handed deliveries are delivered from the hack on the left of the centre line and left-handed deliveries are delivered from the hack on the right of the centre line. A stone delivered from the wrong hack is removed from play, and any displaced stones are replaced, by the non-offending team, to their positions prior to the violation taking place.
- (d) A stone must be clearly released from the hand before it reaches the hog line at the delivery end. If the player fails to do so, the stone is immediately removed from play by the delivering team.
- (e) If a hog line violation stone is not immediately removed and strikes another stone, the delivered stone is removed from play by the delivering team, and any displaced stones are replaced, by the non-offending team, to their positions prior to the violation taking place.
- (f) A stone is in play, and considered delivered, when it reaches the tee line (hog line for wheelchair curling) at the delivery end. A stone that has not reached the relevant line may be returned to the player and redelivered.
- (g) All players must be ready to deliver their stones when their turns come, and not take an unreasonable amount of time to play.
- (h) If a player delivers a stone belonging to the opposing team, that stone is allowed to come to rest, and is then replaced by a stone belonging to the delivering team.
- (i) If a player delivers a stone out of proper rotation, the end continues as if the mistake had not occurred. The player who missed a turn delivers the last stone for that team in that end. If it cannot be determined which player delivered out of proper rotation, the player who delivered the first stone in the end for that team delivers the last stone for that team in that end.

- (j) If a player inadvertently delivers too many stones in one end, the end continues as if the mistake had not occurred and the number of stones allocated to the last player of the offending team shall be reduced accordingly.
- (k) If a team delivers two stones in succession in the same end:
 - (i) the second stone is removed and any displaced stones replaced, by the non-offending team, to their positions prior to the violation taking place. The player who delivered the stone played by mistake, redelivers it as the last stone for the team in that end.
 - (ii) should the infraction not be discovered until after the delivery of a subsequent stone, the end is replayed.

R6. FREE GUARD ZONE (FGZ)

- (a) A stone that comes to rest between the tee line and the hog line at the playing end, excluding the house, is deemed to be within an area designated as the FGZ. Also, stones that are in play, on or before the hog line, after striking stones in the FGZ, are deemed to be in the FGZ.
- (b) If, prior to the delivery of the fifth stone of an end, a delivered stone causes, either directly or indirectly, an opposition stone to be moved from the FGZ to an out-of-play position, then the delivered stone is removed from play, and any displaced stones are replaced, by the non-offending team, to their positions prior to the violation taking place.

R7. SWEEPING

- (a) The sweeping motion is in a side-to-side direction (it need not cover the entire width of the stone), deposits no debris in front of a moving stone, and finishes to either side of the stone.

- (b) A stationary stone must be set in motion before it can be swept. A stone set in motion by a delivered stone, either directly or indirectly, may be swept by any one or more of the team to which it belongs anywhere in front of the tee line at the playing end.
- (c) A delivered stone may be swept by any one or more of the delivering team anywhere in front of the tee line at the playing end.
- (d) No player may ever sweep an opponent's stone except behind the tee line at the playing end, and may not start to sweep an opponent's stone until it has reached the tee line at the playing end.
- (e) Behind the tee line at the playing end, only one player from each team may sweep at any one time. This may be any player of the delivering team, but only the skip or vice-skip of the non-delivering team.
- (f) Behind the tee line, a team has first privilege of sweeping its own stone, but it must not obstruct or prevent its opponent from sweeping.
- (g) If a sweeping violation occurs, the non-offending team has the option of allowing the play to stand, or of placing the stone, and all stones it would have affected, where they would have come to rest had the violation not occurred.

R8. TOUCHED MOVING STONES

- (a) Between the tee line at the delivery end and the hog line at the playing end:
 - (i) If a moving stone is touched, or is caused to be touched, by the team to which it belongs, or by their equipment, the touched stone is removed from play immediately by that team.
 - (ii) If a moving stone is touched, or is caused to be touched, by an opposition team, or by its equipment, or is affected by an external force:
 - 1) If the stone was the delivered stone, it is redelivered

- 2) If the stone was not the delivered stone, it is placed where the team to which it belongs reasonably considers it would have come to rest had it not been touched.

(b) Inside the hog line at the playing end:

- (i) If a moving stone is touched, or is caused to be touched, by the team to which it belongs, or by its equipment, all stones are allowed to come to rest, after which the non-offending team has the option to:
 - 1) remove the touched stone, and replace all stones that were displaced after the infraction to their positions prior to the violation taking place; or
 - 2) leave all stones where they came to rest; or
 - 3) place all stones where it reasonably considers the stones would have come to rest had the moving stone not been touched.
- (ii) If a moving stone is touched, or is caused to be touched, by an opposition team, or by its equipment, all stones are allowed to come to rest, after which the non-offending team places the stones where it reasonably considers the stones would have come to rest, had the moving stone not been touched.
- (iii) If a moving stone is touched, or is caused to be touched, by an external force, all stones are allowed to come to rest, and then placed where they would have come to rest if the incident had not occurred. If the teams cannot agree, the stone is redelivered after all displaced stones have been replaced to their positions prior to the violation taking place. If agreement on those positions cannot be reached, the end is replayed.

(c) Last Stone Draw (LSD) stones:

- (i) If a member of the delivering team touches a moving stone, or causes it to be touched, the stone will be removed and recorded as 185.4 cm (6 ft. 1 in.).
- (ii) If a member of the non-delivering team touches a moving stone, or causes it to be touched, the stone will be redelivered.

- (iii) If an external force touches a moving stone, or causes it to be touched, the stone will be redelivered.

R9. DISPLACED STATIONARY STONES

- (a) If a stationary stone which would have had no effect on the outcome of a moving stone is displaced, or caused to be displaced, by a player, it is replaced, by the non-offending team, to their positions prior to the violation taking place.
- (b) If a stationary stone which would have had no effect on the outcome of a moving stone is displaced, or caused to be displaced, by an external force, it is replaced, with agreement of the teams, to its position prior to the violation taking place.
- (c) If a stone which would have altered the course of a moving stone is displaced, or caused to be displaced, by a player, all stones are allowed to come to rest and then the non-offending team has the option to:
 - (i) leave all stones where they came to rest; or
 - (ii) remove from play the stone whose course would have been altered, and replace any stones that were displaced after the violation to their positions prior to the violation taking place; or
 - (iii) place all stones in the positions the team reasonably considers they would have come to rest had a stone not been displaced.
- (d) If a stone which would have altered the course of a moving stone is displaced, or caused to be displaced, by an external force, all stones are allowed to come to rest, and are then placed in the positions in which they would have come to rest had a stone not been displaced. If the teams cannot agree, the stone is redelivered after all displaced stones have been replaced to their positions prior to the violation taking place. If agreement on those positions cannot be reached, the end is replayed.

- (e) If a displacement is caused by stones deflecting off the sheet dividers, the stones are replaced, by the non-delivering team, to their positions prior to the violation taking place.
- (f) Last Stone Draw (LSD) Stones:
 - (i) If a member of the delivering team displaces a stationary stone, or causes it to be displaced, before the official completes the measurement, the stone will be removed and recorded as 199.6 cm (6 ft. 6.5 in.).
 - (ii) If a member of the non-delivering team displaces a stationary stone, or causes it to be displaced, before the official completes the measurement, the stone is replaced, by the delivering team, to its position prior to the violation taking place.
 - (iii) If an external force displaces a stationary stone, or causes it to be displaced, before the official completes the measurement, the stone is replaced, by the delivering team, to its position prior to the violation taking place.

R10. EQUIPMENT

- (a) No player shall cause damage to the ice surface by means of equipment, hand prints, or body prints. The procedure will be:
 - 1st incident = 1st official on-ice warning, repair damage
 - 2nd incident = 2nd official on-ice warning, repair damage
 - 3rd incident = repair damage and remove player from the game
- (b) No equipment shall be left unattended anywhere on the ice surface.
- (c) Teams must not use electronic communication equipment, or any device to modify the voice, during a game. With the exception of stopwatches that are limited to providing 'time' data only, the use of electronic devices during the games, which provide information to players on the field of play, are forbidden.
- (d) When a properly functioning electronic hog line device is being used:

- (i) The handle must be properly activated so that it is functioning during the delivery, or it will be considered a hog line violation stone.
 - (ii) A glove or mitt must not be worn on the delivery hand during the delivery of a stone. If there is a violation, the delivered stone shall be removed from play, and any displaced stones shall be replaced, by the non-offending team, to their positions prior to the violation taking place.
- (e) A player may change the type of brush or synthetic broom at any time during a game, provided there is no delay. A player choosing to sweep with a corn broom must use only that style of broom during the entire game.
- (f) The use of a delivery stick shall be restricted as follows:
- (i) The delivery stick may not be used in any WCF competition or qualifying event, except wheelchair events.
 - (ii) Players choosing to deliver with a delivery stick must use that device for the delivery of all their stones during the entire game.
 - (iii) The stone must be delivered along a straight line from the hack to the intended target.
 - (iv) The stone must be clearly released from the delivery stick before either foot of the player delivering the stone has reached the tee line at the delivery end. A stone is in play, and considered delivered, when it reaches the hog line at the delivery end.
 - (v) A delivery stick shall not convey any mechanical advantage other than acting as an extension of the arm/hand.
 - (vi) If a stick delivery violation occurs, the delivered stone shall be removed from play, and any displaced stones shall be replaced, by the non-offending team, to their positions prior to the violation taking place.

R11. SCORING

- (a) The result of a game is decided by a majority of points at the completion of the scheduled ends of play, or when a team concedes victory to its opponent, or when one team is mathematically eliminated. If the score is tied at the completion of the scheduled ends, play continues with extra end(s) and the team that scores first wins the game.
- (b) At the completion of an end (when all stones have been played), a team scores one point for each of its own stones located in or touching the house that are closer to the tee than any stone of the opposition.
- (c) The score of an end is decided when the skips or vice-skips in charge of the house agree upon the score. If stones that may have affected the points scored in an end are displaced prior to that decision, the non-offending team receives the benefit that might have accrued from a measurement.
- (d) When determining the score of an end, if teams cannot visually decide which stones are closer to the tee, or whether a stone is touching the house, a measuring device is used. Measurements are taken from the tee to the nearest part of the stone. The person in charge of the house from each team is allowed to observe any measurement that is made by a measuring device.
- (e) If two or more stones are so close to the tee that it is impossible to use a measuring device, the determination is made visually.
- (f) If a decision cannot be reached, either visually or with a measuring device, the stones are considered equal, and:
 - (i) If the measure was to determine which team scored in the end, the end is blanked.
 - (ii) If the measure was to determine additional points, only the stones closer to the tee are counted.

- (g) Should an external force cause the displacement of stones that would have affected the score prior to agreement of the score, the following applies:
- (i) If the displaced stones would have determined which team scored in an end, the end is replayed.
 - (ii) If a team secured a point(s), and the displaced stone(s) would have determined if an additional point(s) was scored, that team has the option of replaying the end or of keeping the point(s) already secured.
- (h) A team concedes a game only when it is the delivering team. When a team concedes the game before the completion of an end, the score of the end is determined at that time, in the following manner:
- (i) If both teams still have stones to be delivered, “X”s are placed on the scoreboard.
 - (ii) When only one team has delivered all of its stones:
 - 1) If the team that delivered all its stones has stone(s) counting, no points are given, “X”s are placed on the scoreboard unless the points are required to determine the outcome.
 - 2) If the team that did not deliver all its stones has stone(s) counting, these points are given and placed on the scoreboard.
 - 3) If no stones are counting, “X”s are placed on the scoreboard.
 - (i) If a team is not available to start a game at the designated time, the following takes place:
 - (i) If the delay of the start of play is 1-15 minutes, then the non-offending team receives one point, and will have last stone in the first end of actual play; one end is considered completed.
 - (ii) If the delay of the start of play is 15-30 minutes, then the non-offending team receives one additional point, and last stone in the first end of actual play; two ends are considered completed.
 - (iii) If play has not started after 30 minutes, then the non-offending team is declared the winner by forfeit.

- (j) The final score of a forfeited game is recorded as “W - L” (win - loss).

R12. INTERRUPTED GAMES

If for any reason, a game is interrupted, the game recommences where play was stopped.

R13. WHEELCHAIR CURLING

- (a) Stones are delivered from a stationary wheelchair.
- (b) When the stone is delivered between the hack and the outermost edge of the top of the house at the delivery end, the chair must be positioned so that at the start of the delivery the stone is positioned on the centre line. When the stone is delivered between the outermost edge of the top of the house and the hog line at the delivery end, the chair must be positioned so that at the start of the delivery the entire width of the stone is within the wheelchair lines.
- (c) During delivery, the feet of the player delivering the stone must not touch the ice surface and the wheels of the chair must be in direct contact with the ice.
- (d) The delivery of the stone is undertaken by the conventional arm/hand release or by the use of an approved delivery stick. Stones must be clearly released from the hand or stick before the stone reaches the hog line at the delivery end.
- (e) A stone is in play when it reaches the hog line at the delivery end. A stone that has not reached the hog line at the delivery end may be returned to the player and redelivered.
- (f) Sweeping is not permitted.

- (g) If a delivery violation occurs, the delivered stone shall be removed from play, and any displaced stones shall be replaced, by the non-offending team, to their positions prior to the violation taking place.
- (h) For WCF wheelchair competitions, each on-ice team must have four players delivering stones and must be comprised of both genders at all times during games. A team violating this rule will forfeit the game.
- (i) All games will be scheduled for 8 ends.

R14. MIXED CURLING

- (a) Each team shall have two male and two female players and the male and female players must deliver stones alternately (M, F, M, F - or - F, M, F, M). No alternate players are permitted.
- (b) If a team plays with three players, the alternate gender order of delivery must be maintained (M, F, M - or - F, M, F). If this occurs while a game is in progress, the delivery rotation can be changed to meet this criterion.
- (c) The skip and vice-skip can be anyone in the team, but they must be from opposite genders.
- (d) All Mixed games are scheduled for 8 ends.
- (e) The team is allowed one coach and one other team official. Only those two persons may sit on the designated coach bench.

R15. MIXED DOUBLES CURLING

- (a) A team is composed of two players, one male and one female. Alternate players are not allowed. A team must forfeit any game(s) in which it fails to have both players playing for the entire game. One coach and one other team official will be allowed for each team.
- (b) The scoring shall be the same as in a regular game of curling. The “positioned” stones that are placed prior to the beginning of each end are eligible to be counted in the scoring.
- (c) Each game will be scheduled for 8 ends.
- (d) Each team shall deliver 5 stones per end. The player delivering the team’s first stone of the end must also deliver the team’s last stone of that end. The other team member shall deliver the team’s second, third and fourth stones for that end. The player delivering the first stone can change from end to end.
- (e) No stone in play, including the “positioned” stones and those in the house, can be moved to an out-of-play position prior to the delivery of the fourth stone of an end (the fourth delivered stone is the first stone that can remove any stone from play). If there is a violation, the delivered stone shall be removed from play, and any displaced stone(s) shall be replaced, by the non-offending team, to their positions prior to the violation taking place.
- (f) Prior to the start of every end, one team shall place its “positioned” stone at the playing end of the sheet in one of two positions, designated A and B. The opponent’s “positioned” stone shall then be placed in whichever position (A or B) remains vacant. The location of these positions shall be as follows:
 - (i) Position A: Placement so that the stone is bisected by the centre line and is either immediately in front of or immediately behind one of 3 points in the ice. The points are placed on the centre line (see diagram):

- 1) at the mid-point between the hog line and the outermost edge of the top of the house.
- 2) 0.915 m. (3 feet) from the mid-point closer to the house.
- 3) 0.915 m. (3 feet) from the mid-point closer to the hog line.

Based on the ice conditions, when no event official is available to make the decision, the teams shall determine the specific placement for each sheet for Position A to be used prior to the start of the pre-game practice and that same placement must be used for the entire game.

- (ii) Position B: Placement so that the stone is bisected by the centre line and is in the back of the 4-foot circle. The back edge of the stone is aligned with the back edge of the 4-foot circle (see diagram).
- (iii) Power Play: Once per game, each team, when it has the decision on the placement of the “positioned” stones, can use the “Power Play” option to position those two stones. The in-house stone (B), which belongs to the team with last stone in that end, is placed on either side of the house with the back edge of the stone touching the tee line, at the point where the 8-foot and 12-foot circles meet. The guard stone (A) is positioned to the same side of the sheet, the same distance that was determined for the centre guards (see diagram). The “Power Play” option cannot be used in extra ends.

Figure No. 1 - Centre Guard

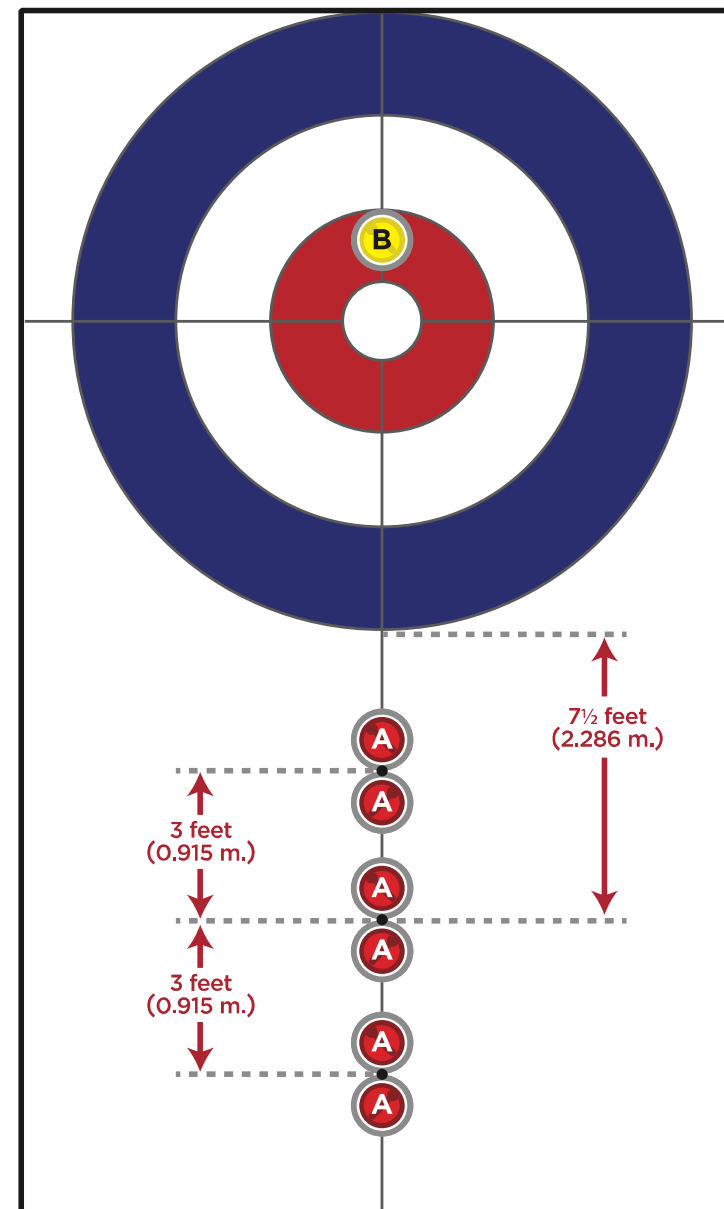
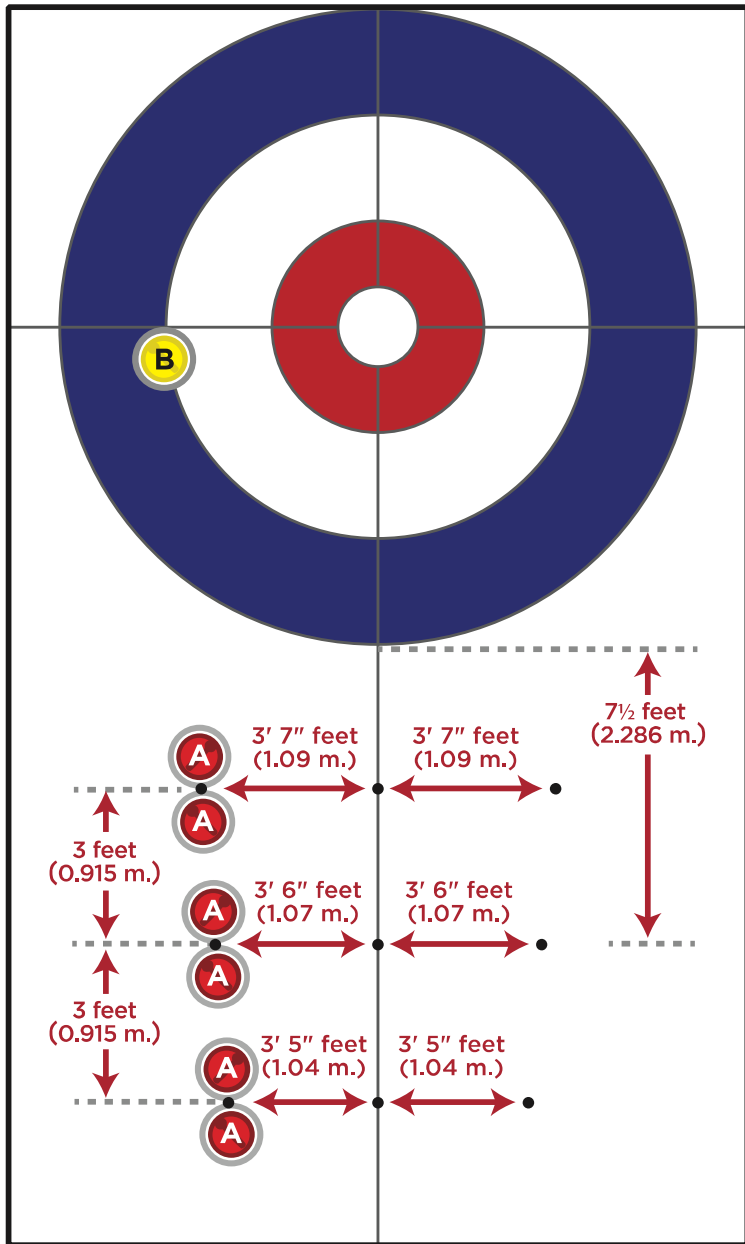

Figure No. 2 - Power Play Option



- (g) The team having the decision on the placement of the “positioned” stones shall be:
 - (i) Teams opposing each other in the game shall use the Last Stone Draw (LSD) to determine which team has the decision in the first end. The team with the lesser LSD distance shall have the decision on the placement.
 - (ii) Following the first end, the team that did not score shall have the decision on the placement.
 - (iii) If neither team scores in an end, the team that delivered the first stone in that end shall have the decision on placement in the next end.
- (h) The team whose “positioned” stone is placed in Position A (in front of the house) shall deliver the first stone in that end, and the team whose “positioned” stone is placed in Position B (in the house) shall deliver the second stone in that end.
- (i) While the team is in the process of delivery, the non-delivering player may be anywhere on the ice surface of the team’s sheet. After delivery, either or both players may sweep their delivered stone and any stones set in motion that belong to their team anywhere in front of the tee line at the playing end. This applies during all of the team’s delivered stones, including the LSD.
- (j) If a delivery violation occurs, the delivered stone shall be removed from play, and any displaced stones shall be replaced, by the non-offending team, to their positions prior to the violation taking place. Should the infraction not be discovered until after the delivery of a subsequent stone, play continues as if the infraction had not occurred.

R16. PROHIBITED SUBSTANCES

The use of all performance-enhancing drugs, without therapeutic exemption, whether taken knowingly or otherwise, is unethical and prohibited. If such use occurs the player(s) will be disqualified from the competition, their Member Association will be notified, and it could lead to further suspension.

R17. INAPPROPRIATE BEHAVIOUR

Improper conduct, foul or offensive language, equipment abuse, or wilful damage on the part of any team member is prohibited. Any violation may result in suspension of the offending person(s) by the curling organisation having jurisdiction.

RULES OF COMPETITION

C1. GENERAL

- (a) The rules of play for WCF competitions are the current rules of the World Curling Federation (WCF). If there are any modifications, these are explained during the Team Meeting.
- (b) The dates of the WCF competitions are determined by the Executive Board of the WCF.
- (c) The playing and event schedules are determined by the WCF in consultation with the Host Committee.
- (d) Smoking, including e-smoking devices, within the confines of the competition area at WCF competitions is prohibited.
- (e) The WCF Anti-Doping rules and procedures, which meet the requirements of the World Anti-Doping Agency are applicable, and published in the WCF Anti-Doping Pamphlet.
- (f) Any variation from the recommended sheet measurements must be approved by the WCF.
- (g) For WCF Championships, gold medals are awarded to the first placed team, silver medals to the second placed team, and bronze medals to the third placed team. The 5 players (2 for Mixed Doubles, 4 for Mixed) and their coach, receive medals, if they are in attendance and fulfil their team obligations, and are allowed on the podium. For the Olympic Winter Games, Youth Olympic Games and the Paralympic Winter Games, only the players receive medals and are allowed on the podium.

C2. PARTICIPATING TEAMS

- (a) Each team is designated by its Association/Federation.
- (b) If a designated team is unable or unwilling to participate, the Association/Federation involved nominates another team.
- (c) The teams for each event must be declared at least 14 days prior to the start of the competition. Notification of a replacement must be done by the end of the team meeting.
- (d) All players at a WCF competition must be bona fide members in good standing of their Associations/Federations.
- (e) To be eligible to play in the World Junior Curling Championships (WJCC) and qualifying events, a player must be less than 21 years of age by the end of the 30th day of June of the year immediately preceding the year in which the championship is to take place.
- (f) To be eligible to play in the World Senior Curling Championships (WSCC) and qualifying events, a player must be not less than 50 years of age by the end of the 30th day of June of the year immediately preceding the year in which the championship is to take place.
- (g) To be eligible to play in the World Wheelchair Curling Championship (WWhCC) and qualifying events, a player must have substantial demonstrable impairments in leg/gait function and use a wheelchair for daily mobility, or qualify within the eligibility criteria.
- (h) All players and their coach must attend the Team Meeting. Failure to do so, without approval of the Chief Umpire, results in the forfeit of the last stone advantage for that team in its first game. Only the team players, one coach, a Team Leader, and a translator if necessary, are allowed to attend. For teams in post round robin play, the mandatory one or two team members (players and/or coach) must attend the play-off meetings, or the team will lose the choices (first or second practice, colour of stones, etc.) to which they would normally be entitled.
- (i) The team delivery rotation, skip and vice-skip positions, alternate player, and coach are listed on the original team line-up form, and submitted to the Chief Umpire at the end of the Team Meeting. The team leader / national coach / translator, if appropriate, are also listed. A game team line-up form (paper or electronic) must be submitted to the Chief Umpire at least 15 minutes prior to the pre-game practice to either confirm the original team line-up or to indicate a change.
- (j) A team must start a competition with four players (two for Mixed Doubles) delivering stones. A team will forfeit each game at the start of the competition, until it can start a game with four qualified players.

- (k) While a game is in progress, the coach, the alternate player, and all other team officials are prohibited from communicating with their team or being within the playing area except during specifically designated breaks or a team time-out. This restriction applies to all verbal, visual, written, and electronic communication, including any attempt to signal for the implementation of a team time-out. The coach, the alternate player, and one team official may participate in the pre-event and the pre-game practices, but may not communicate with their team during the LSD. During the game, there shall be no unauthorised communications or broadcasts of any sort from the coach bench to anyone who is not sitting in that designated area. Coaches and other team personnel sitting on the coach bench cannot watch or listen to broadcasts. For any violation the offending person will be removed from the coach's bench for that game.
- (l) For the purpose of identification to the media and to the public, teams are referred to by the name under which their Association/Federation competes, and by the name of the skip.

C3. UNIFORMS / EQUIPMENT

- (a) All team members wear identical uniforms and appropriate footwear when accessing the field of play for games or practice sessions. The team wears light-coloured shirts and playing jackets/sweaters when assigned stones with light-coloured handles, and wears dark-coloured shirts and playing jackets/sweaters when assigned stones with dark-coloured handles. The colour of these garments shall be registered with the WCF prior to the start of each competition. The team coaches/officials must wear a team or national uniform whenever accessing the field of play. Red is considered to be a dark colour.

- (b) Each shirt and jacket/sweater has the player's surname, in 5.08 cm. (2-in.) or larger letters, across the upper back of the garment, and the name under which their Association/Federation competes, in 5.08 cm. (2-in.) or larger letters, across the back above the waist. If desired, a national emblem may also be worn on the back, but only in addition to the name under which the Association/Federation competes, and displayed between that name and the player's surname. When two or more team members have the same surname, the first letter(s) of their given names are also displayed.
- (c) Advertising is permitted on a player's clothing or equipment strictly in accordance with the current guidelines issued by the WCF. The WCF may, in its sole discretion, forbid the use of any clothing or equipment that it feels is unacceptable or unsuitable for WCF competition play. The WCF Dress Code is contained within this book.
- (d) A player or coach with an improper uniform shall be denied access to the field of play and the coach bench.

C4. PRE-GAME PRACTICE

- (a) Prior to the start of every game at WCF competitions, each team is allowed a pre-game practice on the sheet on which it will be playing.
- (b) The time and duration of the pre-game practice is given at the Team Meeting.
- (c) The schedule for pre-game practices during the round robin will be predetermined as much as possible, based on the criterion that each team has first and second practice an equal number of times. For the round robin games where this cannot be predetermined the winner of a coin toss will have the choice of first or second practice.

- (d) In post round robin games, when the Last Stone First End has been pre-determined, the team delivering the last stone in the first end practices first.
- (e) If the Chief Ice Technician deems it necessary, the ice will be cleaned, and the slide path re-pebbled, after the pre-game practice.

C5. LENGTH OF GAMES

- (a) In competitions in which 10 ends are scheduled, a minimum of 6 ends must be completed in round robin and tie-breaker games, and 8 ends must be completed in play-off games.
- (b) In competitions in which 8 ends are scheduled, a minimum of 6 ends must be completed.

C6. GAME TIMING

- (a) Each team shall receive 38 minutes of thinking time for a 10 end game and 30 minutes of thinking time for an 8 end game (38 minutes in wheelchair curling, 22 minutes in mixed doubles curling). This time is recorded, and visible to the teams and coaches, throughout the game.
- (b) When a team delays the start of a game, the thinking time allotted to each team is reduced by 3 minutes 45 seconds (4 minutes 45 seconds in wheelchair curling, 2 minutes 45 seconds in mixed doubles curling) for each end which was considered completed (Rules of Curling R11(i) apply).
- (c) When extra ends are required, the game clocks are reset and each team receives 4 minutes 30 seconds of thinking time for each extra end (6 minutes in wheelchair curling, 3 minutes in mixed doubles curling).

- (d) The game and each end starts when the allotted break time expires. The delivering team's game clock will not run during the start of the game/end unless that team is delaying the start (no forward motion from the hack, or the stone not released from the delivery stick), then its game clock will be started. If there is no delay, the first game clock to start in each end will be that of the team delivering the second stone.
- (e) Once all of the criteria below are met, the non-delivering team becomes the delivering team, and its game clock is started:
 - (i) all stones have come to rest or have crossed the back line and
 - (ii) stones that are displaced due to violations by the delivering team, and require repositioning, are returned to their positions prior to the violation and
 - (iii) the playing area has been relinquished to the other team, the person in charge of the house has moved behind the back line and the deliverer and sweepers have moved to the sides of the sheet
- (f) A team's game clock stops once the stone has reached the tee line (hog line in wheelchair curling) at the delivery end.
- (g) A team delivers stones only when its game clock is running or scheduled to be running. Any violation results in the stone being redelivered after any displaced stones have been returned, by the non-offending team, to their positions prior to the violation. The time clock of the offending team will start as soon as any displaced stones have been repositioned and will stop when the redelivered stone reaches the tee line (hog line for wheelchair curling) at the delivering end.
- (h) If stones need to be repositioned due to a violation caused by an external force both game clocks are stopped.
- (i) Game clocks are stopped at any time an umpire intervenes.

- (j) After the teams have agreed on the score for an end, a break occurs, when neither game clock is running. If a measurement is required, the break begins at the completion of that measurement. The length of the break between ends, which may vary due to television requirements or to other external factors, is determined for each competition and explained at the Team Meeting. When a break is of 3 minutes or more, the teams are informed when 1 minute of the break remains. Teams should not deliver the first stone of the next end until less than 10 seconds of the break time remains. The delivering team's game clock will start at the conclusion of the break unless the player is in the process of delivery. The length of the break will normally be:
 - (i) 1 minute at the completion of each end, except as noted in (j)(ii). Teams cannot meet, or communicate in any way, with a coach, the alternate player or any other team official.
 - (ii) 5 minutes at the completion of the end that defines the halfway point in the game. Teams are allowed to meet, within the playing area, with any player and team official that is authorised to be on the coach bench for that game.
- (k) If a player is allowed to redeliver a stone, the umpire decides if the time required is to be deducted from the game time for that team.
- (l) If an end is to be replayed, the game clocks are reset to the time recorded at the completion of the previous end.
- (m) If an umpire determines that a team is unnecessarily delaying a game, the umpire notifies the skip of the offending team and, after that notification, if the next stone to be delivered has not reached the tee line (hog line in wheelchair curling) at the delivery end within 45 seconds, the stone is removed from play immediately.
- (n) Each team must complete its part of a game within the time given, or forfeit the game. If a stone reaches the tee line (hog line in wheelchair curling) at the delivery end before time expires, the stone is considered delivered in time.

- (o) A team whose clock has run due to a timing error (wrong clock running) will have double the agreed error time added back to its clock.

C7. TEAM TIME-OUTS / TECHNICAL TIME-OUTS

- (a) Team time-outs will not be allowed if time clocks are not being used.
- (b) Each team may call one 60 second team time-out during each game and one 60 second team time-out in each extra end.
- (c) Procedures for a team time-out are as follows:
 - (i) Only the players on the ice may call a team time-out.
 - (ii) Team time-outs may be called by any on-ice team player only when that team's game clock is running. Players signal a team time-out by using a "T" hand signal.
 - (iii) A team time-out (when the game clock is stopped) starts as soon as the time-out is called and consists of 'travel time' to get to the team plus 60 seconds. The amount of travel time will be determined at each event by the Chief Umpire.
 - (iv) Only one person, who is sitting in the designated coaching area and a translator, if required, of the team that called the team time-out is allowed to meet with the team. This person, or persons if a translator is required, must use the designated route to the team. Where walkways are beside the sheet, that person must not stand on the playing ice surface.
 - (v) The team is notified when there are 10 seconds remaining in the team time-out.
 - (vi) When the team time-out has expired, the person(s) from the coach's bench must stop conferring with the team and leave the playing area immediately.
- (d) A technical time-out may be called by a team to request a ruling, for an injury or in other extenuating circumstances. Game clocks will be stopped during technical time-outs.

C8. STONE ASSIGNMENT / LAST STONE DRAW

- (a) The team listed first in the draw schedule for the round robin games will play the stones with the dark coloured handles; the team listed second will play with the stones with the light coloured handles.
- (b) For games requiring Last Stone Draws (LSD), at the conclusion of each team's pre-game practice, two stones will be delivered to the tee at the home end, by different players - the first stone with a clockwise and the second with a counter-clockwise rotation. A player (alternate) that delivers an LSD stone does not have to play in that game. Sweeping is allowed (except in wheelchair curling). In Mixed curling each gender must deliver one stone, but the team selects the sweepers independent of their gender.

The first stone will be measured and removed from play before the second stone is delivered. The distances recorded for each stone will be added together to give the team its LSD total for that game. The team with the lesser LSD total will have the choice of delivering the first or second stone in the first end of that game. If the LSD totals for both teams are the same, the individual LSD stones are compared and the best non-equal LSD has the choice of delivering first or second stone in the first end. When both teams have the exact same individual LSD stone distances, a coin toss will be used to determine that choice.

- (c) LSD distances will be measured and recorded in the following manner:
 - (i) All measurements will be from the tee to the nearest part of the stone, but the LSD distances will be displayed in centimetres as the distance from the tee to the center of the stone.
 - (ii) The official radius to be used in WCF championships is 14.2 cm.
 - (iii) To any result measured, the radius of 14.2 cm has to be added. This means that the distance for stones not in the house is 185.4 cm + 14.2 cm = 199.6 cm.

(iv) Stones covering the tee will be measured from two locations (holes) at the edge of the 4ft circle. These two locations make a 90 degree angle with the centre hole and are 0.61 m (2 feet) from the centre hole.

- (d) The number of LSD stones, and the number of clockwise and counter-clockwise deliveries for each player, will be determined at each competition depending upon the number of games in the round robin. Based on the Original Team Line-up form, the four players (2 in Mixed Doubles) have to fulfill the minimum number of LSD deliveries. If there is a violation where the minimum requirements are not fulfilled, the appropriate LSD(s) will be recorded as 199.6 cm. LSD stones delivered by the alternate can be combined at the end of the round robin with only one other player, so that this player fulfills the minimum required number of LSD stones.

Round robin games	Number of LSD stones	Minimum for each player
4	8	2 stones, 1 clockwise + 1 counter-clockwise
5	10	2 stones, 1 clockwise + 1 counter-clockwise
6	12	2 stones, 1 clockwise + 1 counter-clockwise
7	14	3 stones, minimum 1 clockwise + minimum 1 counter-clockwise
8	16	3 stones, minimum 1 clockwise + minimum 1 counter-clockwise
9	18	4 stones, 2 clockwise + 2 counter-clockwise

10	20	4 stones, 2 clockwise + 2 counter-clockwise
11	22	4 stones, 2 clockwise + 2 counter-clockwise

- (e) For Mixed Doubles each player delivers an equal number of clockwise and counter-clockwise LSD stones. If there are an odd number of games a variation of one rotation per player has to occur.
- (f) When round robin play (one group) is used at WCF competitions, with each competing team playing all other teams, first stone in the first end of post round robin games is determined as follows:
- (i) The team with the better win/loss record has the choice of playing first or second stone in the first end.
 - (ii) If the teams have the same win/loss record, the winner of their round robin game has the choice of playing first or second stone in the first end.
 - (iii) Notwithstanding (i) and (ii), for competitions that use the Page play-off system, the team that wins the 1 versus 2 game has the choice of delivering the first or second stone in the first end of the gold medal game; the team that loses the semi-final game has the choice of delivering the first or second stone in the first end of the bronze medal game.
- (g) At WCF competitions when teams play a round robin in separate groups, for the play-off game(s) if the teams are from the same group C8 (f) will be used, and if the teams are from different groups, the team with the lesser DSC has choice of either the first or second practice or the stone handle colour. Then regular LSD procedures (without minimum requirements), will determine which team has the choice of delivering the first or second stone in the first end.
- (h) In post round robin games where the team delivering the first stone in the first end has been pre-determined, the team delivering the first stone of the first end has the choice of stone handle colour.

C9. TEAM RANKING PROCEDURE / DRAW SHOT CHALLENGE

- (a) During the round robin portion of a competition, teams with the same win-loss record will be listed alphabetically, by their three letter code, and ranked equal.
- (b) The following criteria (in order) will be used to rank the teams at the completion of the round robin:
- (i) Teams will be ranked according to their win/loss record;
 - (ii) If two teams are tied, the team that won their round robin game will be ranked higher;
 - (iii) Where three or more teams are tied, the record of the games between the tied teams shall provide the ranking (should this procedure provide a ranking for some teams but not all, then the record of the games between the remaining teams that are still tied shall determine the ranking);
 - (iv) For all remaining teams whose ranking cannot be determined by (i) or (ii) or (iii), ranking is determined using the Draw Shot Challenge (DSC). The DSC is the average distance of all the individual Last Stone Draw stones, which were delivered by a team during the round robin.
Where a total of 11 or fewer individual stones will be delivered, the single least favourable result is automatically eliminated when calculating the average distance. Where more than 11 individual stones will be delivered, the two least favourable results will be eliminated when calculating the average distance.
The team with the lesser DSC receives the higher ranking. If the DSCs are equal then the team with the best non-equal counting LSD receives the higher ranking. In the case where all counting LSDs are equal the team ranked higher in the WCF World Rankings is ranked higher.
 - (v) When teams compete in different groups and do not qualify for the play-offs, the final ranking will be determined by comparing the DSCs from the teams in all groups with the same ranking, with the best DSC being ranked highest.

- (vi) In events where a single loss eliminates a team from the competition, teams eliminated during the same session will be listed alphabetically, by their three letter code, and ranked equal.
- (c) When teams are tied for a play-off position, a maximum of one session of tie-breakers will be played to determine which team(s) advances to the play-offs. Team(s) can be eliminated, without playing an extra game, if more than one session of tie-breakers would be required.
- (d) When teams are tied for a challengeable position, a maximum of one session of tie-breakers will be played. If more than one session of tie-breakers would be required, team(s) can avoid the challengeable position without winning an extra game.
- (e) When teams are tied for a relegation position, a maximum of one session of tie-breakers will be played. If more than one session of tie-breakers would be required, team(s) can avoid or be placed in a relegation position without playing an extra game.
- (f) In some circumstances a single game could decide for a team both relegation and challengeable positions. When multiple teams are tied for the challengeable position after tie-breaker games, the WCF team ranking procedure will decide the team to be challenged.

C10. UMPIRES

- (a) The WCF appoints a Chief Umpire and the Deputy Chief Umpire(s) for every WCF competition. These officials should include both men and women. Officials are approved by their respective Associations/Federations.
- (b) The umpire determines any matter in dispute between teams, whether or not the matter is covered by the rules.

- (c) An umpire may intervene at any time during a competition, and give directions concerning the placement of stones, the conduct of players and adherence to the rules.
- (d) The Chief Umpire, when authorised, may intervene at any time in any game and give such directions concerning the conduct of the game as is considered proper.
- (e) An umpire may delay a game for any reason and determine the length of the delay.
- (f) All matters pertaining to the rules are adjudicated by an umpire. In the event that there is an appeal against an umpire's decision, the decision of the Chief Umpire is final.
- (g) The Chief Umpire may eject a player, coach or team official from a game for what is considered to be unacceptable conduct or language. The ejected person must leave the competition area and take no further part in that game. When a player is ejected from a game, an alternate player may not be used in that game, for that player.
- (h) The Chief Umpire may recommend to the curling organisation having jurisdiction the disqualification, or suspension, of any player, coach or team official from present or future competitions.

COMPETITIONS - THE PLAYDOWN SYSTEMS

Olympic Winter Games (OWG) - Men & Women

- 10 teams for each gender... 1 team from the Host National Olympic Committee (NOC) + 7 teams from the NOCs which gained the most qualification points from the two previous Men's and Women's World Curling Championships + 2 teams from the Olympic Qualification Event (OQE) which is open to teams which played in any of the four previous Men's or Women's World Curling Championships and did not gain sufficient qualification points to directly qualify for the OWG. Also, the third place teams from the PACC events held during the Olympic cycle will be allocated a spot in the Olympic Qualification Event, if they have not already qualified by their participation in the WCCs.
- Teams placed in one group, playing a round robin to establish the top four ranked teams. If required, one session of tie-breakers will be used to determine those teams.

Play-off System: Semi-finals with 1 v 4 and 2 v 3; winners play in the final (for the gold and silver medals), losers play in the bronze medal game.

Olympic Winter Games (OWG) - Mixed Doubles

- 8 teams... 1 team from the Host National Olympic Committee (NOC) + 7 teams from the NOCs which gained the most qualification points from the two previous World Mixed Doubles Curling Championships.
- Teams placed in one group, playing a round robin to establish the top four ranked teams. If required, one session of tie-breakers will be used to determine those teams.

Play-off System: Semi-finals with 1 v 4 and 2 v 3; winners play in the final (for the gold and silver medals), losers play in the bronze medal game.

Paralympic Winter Games (PWG) - Mixed Gender Teams

- 12 teams ... 1 team from the Host National Paralympic Committee (NPC) + 11 teams from the NPCs which gained the most qualification points from the three previous World Wheelchair Curling Championships.
- Teams placed in one group, playing a round robin to establish the top four ranked teams.

Play-off System: Semi-finals with 1 v 4 and 2 v 3; winners play in the final (for the gold and silver medals), losers play in the bronze medal game.

Winter Youth Olympic Games (YOG)

- The National Olympic Committees (NOCs) will collect points from the World Curling Federation's World Junior Curling Championships (WJCC) and World Junior-B Curling Championships (WJBCC). In the event that a specific Challenge event is needed for the Americas, it will be added to the qualification timeline.

The 16 Mixed teams will be selected (based on the highest number of points accumulated) in the following manner:

- 1 team guaranteed to the host National Olympic Committee (NOC)
- 2 teams from North America
- 1 team from South America
- 3 teams from Asia
- 1 team from Oceania
- 8 teams from Europe

The points shall be awarded on the following basis:

WJCC	WJBCC
1 st = 20 points	1 st = awarded at WJCC
2 nd = 18 points	2 nd = 8 points
3 rd = 17 points	3 rd = 6 points
4 th = 16 points	4 th = 5 points
5 th = 15 points	5 th = 4 points
6 th = 14 points	6 th = 3 points
7 th = 13 points	7 th = 2 points
8 th = 12 points	8 th = 1 points
9 th = 11 points	
10 th = 10 points	

World Curling Championships - Men (WMCC) & Women (WWCC)

- 12 teams (qualification process explained on Page 46).
- Teams placed in one group, playing a round robin and one session of tie-breaker games if required, to establish the top four ranked teams.

Play-off System: Page: Team ranked 1st plays against the team ranked 2nd. The winner advances to the final game, the loser goes to the semi-final game. Team ranked 3rd plays against the team ranked 4th. The winner advances to the semi-final game, the loser goes to the bronze medal game. The winner of the semi-final advances to the final, the loser goes to the bronze medal game.

World Junior Curling Championships (WJCC) - Junior Men & Junior Women

- 10 teams for each gender... 1 team from the Host Association/Federation, top 6 highest ranked Association/Federation from the previous year's WJCC and top 3 teams from the previous WJBCC.
- Teams placed in one group, playing a round robin and one session of tie-breaker games if required, to establish the top four ranked teams.

Play-off System: The same system used for the Men's and Women's World Curling Championships.

World Junior-B Curling Championships (WJBCC) - Junior Men & Junior Women

- Open to junior teams from all WCF Member Associations that have not already qualified for the next WJCC. Three teams will qualify from this event.
- If 1-10 teams enter they will be placed in one group, playing a round robin to establish the top four ranked teams.

Play-off system: The same system used for the Men's and Women's World Curling Championships.

- If more than 10 teams enter they will be placed into groups which meet the schedule requirements. The groups play a round robin to establish the teams required for the quarter-final play-offs.

Play-off System : At the end of the round robin series, and if necessary one session of tie-breaker games, there must be a ranking for 1st, 2nd, 3rd and 4th (if two groups); 1st, 2nd and 3rd (if three groups); 1st and 2nd (if four groups).

Where there are three groups the 1st and 2nd ranked teams qualify directly for the quarter-finals, as well as the 3rd ranked team with the best Draw Shot Challenge (DSC) result. The other two 3rd ranked teams play a qualification game to decide the last team entered into the quarter-finals.

The winners of the quarter-finals play in the semi-finals.

The losers of the semi-finals play in the Bronze Medal game.

The winners of the semi-finals play in the Gold Medal game.

Winter University Games (WUG) - Men & Women University Students

- 10 teams for each gender... 1 team from the Host Association + 9 teams according to FISU entry regulations.
- Teams placed in one group, playing a round robin and one session of tie-breaker games if required, to establish the top four ranked teams.

Play-off System: Semi-finals with 1 v 4 and 2 v 3; winners play in the final (for the gold and silver medals), losers play in the bronze medal game.

World Wheelchair Curling Championship (WWhCC) - Mixed Gender Teams

- 10 teams ... 1 team from the Host Association + 7 teams from the Associations which qualified from the previous WWhCC + 2 teams from the Associations which qualified through the World Wheelchair-B Curling Championship (WWhBCC).
- Teams placed in one group, playing a round robin and one session of tie-breaker games if required, to establish the top four ranked teams.

Play-off System: The same system used for the Men's and Women's World Curling Championships.

World Wheelchair-B Curling Championship (WWhBCC) - Mixed Gender Teams

- Open to teams from Associations that have not already qualified for the next WWhCC. Two teams will qualify from this event.
- If 1-10 teams enter they will be placed in one group; if more than ten teams enter they will be placed in two groups. The group(s) play a round robin to establish the teams required for the play-offs.

Play-off System: a) if one group: The same system used for the Men's and Women's World Curling Championships. The 1st and 2nd place teams qualify for the next WWhCC.

b) if two groups: 1st place in both groups qualify for the semi-finals; qualification games A2 v B3 and A3 v B2 winners qualify for semi-finals; semi-finals and finals; the 1st and 2nd place teams qualify for the next WWhCC.

World Mixed Doubles Curling Championship (WMDCC)

Open number of entries (qualification process and play-off system explained Page 47-48)

World Mixed Curling Championship (WMxCC)

Open number of entries (qualification process and play-off system explained Page 47-48)

World Senior Curling Championships (WSCC) - Men & Women

Open number of entries (qualification process and play-off system explained Page 47-48)

Pacific-Asia Curling Championships (PACC) - Men & Women

Open to teams from the Pacific-Asia Curling Zone (qualification process and play-off system explained on Page 49).

QUALIFICATION - WORLD CHAMPIONSHIPS MEN & WOMEN

Hosting Zone: Pacific-Asia	1 team	To the Host Association / Federation.
	1 team (Pacific-Asia)	Winner of the Pacific-Asia Curling Championship (PACC), an annual Pacific-Asia Zone competition, the winner (or, if the winner is the hosting Assn/Fed, the runner-up) qualifies for the WCC.
	2 teams (Americas)	The Americas Zone Association/Federation that finished highest at the previous WCC is automatically qualified. The 2nd ranked American Assn/Fed, from the previous WCC, will be involved with any "challenges" that might come from other WCF Members in the Americas. If there is no challenge, that Assn/Fed is automatically re-qualified. If a challenge event is necessary, the winner of that event will qualify for the next WCC.
	8 teams (Europe)	The 8 European Zone Assn/Fed that earned their entries through a qualification system that is determined by the World Curling Federation.

Hosting Zone: America	1 team	To the Host Association / Federation.
	2 teams (Pacific-Asia)	Winner and Runner-up Assn/Fed from the Pacific-Asia Curling Championship, an annual Pacific-Asia Zone competition.
	1 team (Americas)	The Americas Zone Assn/Fed from the previous WCC that is not hosting the next WCC will be involved with any "challenges" that might come from other WCF Members in the Americas. If there is no challenge, that Assn/Fed is automatically re-qualified. If a challenge event is necessary, the winner qualifies for the next WCC.
	8 teams (Europe)	The 8 European Zone Assn/Fed that earned their entries through a qualification system that is determined by the World Curling Federation.

Hosting Zone: Europe	1 team	To the Host Association / Federation.
	2 teams (Pacific-Asia)	Winner and Runner-up Assn/Fed from the Pacific-Asia Curling Championship, an annual Pacific-Asia Zone competition.
	2 teams (Americas)	The Americas Zone Association/Federation that finished highest at the previous WCC is automatically qualified. The 2nd ranked American Assn/Fed, from the previous WCC, will be involved with any "challenges" that might come from other WCF Members in the Americas. If there is no challenge, that Assn/Fed is automatically re-qualified. If a challenge event is necessary, the winner of that event will qualify for the next WCC.
	7 teams (Europe)	The 7 European Zone Assn/Fed that earned their entries through a qualification system that is determined by the World Curling Federation.

QUALIFICATION - WORLD JUNIOR CHAMPIONSHIPS (WJCC)

All Zones	1 team	To the Host Association / Federation.
	6 teams	The top six (6) teams, excluding the host, from the previous WJCC.
	3 teams	The top three (3) teams from the previous WJBCC.

WORLD SENIORS (WSCC), WORLD MIXED DOUBLES (WMDCC) & WORLD MIXED CURLING CHAMPIONSHIP (WMxCC)

- An Association's team is made up of curlers who are bona fide members of that Association and who fulfil the eligibility criteria for playing for that Association.
- The World Curling Federation reserves the right to adjust the system of play.

ENTRIES	PLAYING SYSTEM	PLAY-OFFS	FINAL RANKINGS
1-10 Entries	ONE Group Round robin + One session of tie-breakers if required + Play-offs	Olympic play-off system with top four teams as shown in the chart on page 64	Teams ranked 1- 10 as per WCF ranking procedure
11- 20 Entries Group-A 1,4,5,8,9,12,13,16,17,20 Group-B 2,3,6,7,10,11,14,15,18,19 Rankings from the previous event. MAs that did not play in that event will be ranked (at the end of the list) according to the WCF World Ranking	TWO Groups Group round robins + One session of tie-breakers if required to determine top 3 teams in each group + Qualification games, semi-finals and medal games	Top teams qualify for the semi-finals; qualification games A2 v B3 and A3 v B2 to determine last teams in the semi-finals	Teams in each group will be ranked as per WCF ranking procedure DSC results are used for the final ranking of the teams that did not qualify for the play-offs, when comparing teams with the same rank but from a different group Final ranking will be established from 1 - 20
21-30 Entries Group-A 1,6,7,12,13,18,19,24,25,30 Group-B 2,5,8,11,14,17,20,23,26,29	THREE Groups Group round robins + One session of tie-breakers if required to determine the top 3 teams in each group	Quarter-finals as shown in the chart on page 65 When qualification games are played, the losers will be ranked equal and listed alphabetically by 3-	Teams in each group will be ranked as per WCF ranking procedure DSC results are used for the final ranking of the teams that did not qualify

PACIFIC - ASIA CURLING CHAMPIONSHIPS (PACC)

Qualification - World Curling Championships (WCC)

World Curling Federation (WCF) determines the System of Play

One team qualifying:

ENTRIES	PLAYING SYSTEM	PLAY-OFFS	QUALIFICATION
6 or fewer Entries	One group Double round robin + One session of tie-breakers if required to determine top 4 teams + Play-offs	Olympic play-off system with top four teams as shown in the chart on page 64	Winner of the gold medal qualifies for the WCC (if winner is the next WCC hosting MA, then silver medal winner qualifies for the WCC)
7 or more Entries	One group Single round robin + One session of tie-breakers if required to determine top 4 teams + Play-offs		Teams ranked as per WCF ranking procedure

Two teams qualifying:

ENTRIES	PLAYING SYSTEM	PLAY-OFFS	QUALIFICATION
6 or fewer Entries	One group Double round robin + One session of tie-breakers if required to determine top 4 teams + Play-offs	Olympic play-off system with top four teams as shown in the chart on page 64	Winner of the gold and silver medal qualify for the WCC (if gold or silver medal winner is the next WCC hosting MA, then bronze medal winner qualifies for the WCC)
7 or more Entries	One group Single round robin + One session of tie-breakers if required to determine top 4 teams + Play-offs		Teams ranked as per WCF ranking procedure

<p>Group-C 3,4,9,10,15,16,21,22,27,28</p> <p>Rankings from the previous event. MAs that did not play in that event will be ranked (at the end of the list) according to the WCF World Ranking.</p>	<p>+ One qualification game to determine the last team in the quarter-finals + Quarter-finals, semi-finals and medal games</p>	<p>letter country code.</p> <p>When quarter-final games are played the losers will be ranked equal (5th) and listed alphabetically by 3-letter country code.</p>	<p>for the play-offs or the qualification games, when comparing teams with the same rank but from a different group</p> <p>Final ranking will be established from 1 – 30</p>
<p>31-40 Entries</p> <p>Group-A 1,8,9,16,17,24,25,32,33,40</p> <p>Group-B 2,7,10,15,18,23,26,31,34,39</p> <p>Group-C 3,6,11,14,19,22,27,30,35,38</p> <p>Group-D 4,5,12,13,20,21,28,29,36,37</p> <p>Rankings from the previous event. MAs that did not play in that event will be ranked (at the end of the list) according to the WCF World Ranking.</p>	<p>Four Groups</p> <p>Group round robins + One session of tie-breakers if required to determine the top 3 teams in each group + Four qualification games to determine the last team in the quarter-finals + Quarter-finals, semi-finals and medal games</p>	<p>Qualification games: A2 v B3, A3 v B2, C2 v D3 and C3 v D2 Quarter-finals as shown in the chart on page 65</p> <p>When qualification games are played, the losers will be ranked equal and listed alphabetically by 3-letter country code.</p> <p>When quarter-final games are played the losers will be ranked equal (5th) and listed alphabetically by 3-letter country code.</p>	<p>Teams in each group will be ranked as per WCF ranking procedure</p> <p>DSC results are used for the final ranking of the teams that did not qualify for the play-offs or the qualification games, when comparing teams with the same rank but from a different group</p> <p>Final ranking will be established from 1 – 40</p>

EUROPEAN CURLING CHAMPIONSHIPS (ECC)

- The European Curling Championship qualifies European teams to the World Curling Championships.
- If the next WCC is in Europe - the host Association has a guaranteed place + the 6 highest ranked Associations from the A Division + the winner of the “ECC World Challenge”.
- If the next WCC is outside of Europe - the top 7 highest ranked Associations from the A-Division + the winner of the “ECC World Challenge” qualify for the WCC.
- “ECC World Challenge” - the last team from A-Division to qualify plays a best-of-three challenge against the winner of the B-Division (if either of those teams are the host of the next WCC the next team in line will play the challenge). The winner qualifies for the WCC.
- The World Curling Federation reserves the right to adjust the system of play. In the event of no entries for the C-Division, B9 + B10 Women and B15 + B16 Men remain in the B-Division.

ENTRIES	PLAYING SYSTEM	PLAY-OFFS	FINAL RANKINGS
A Division Men and Women 10 Teams A1 - A8 + B1 + B2 Rankings taken from the previous ECC	One Group: Round robin + Tie-breakers (one session) if required to determine top 4 teams + Play-offs	Olympic play-off system with top four teams as shown in the chart on page 64	Teams ranked A1- A10 as per WCF ranking procedure. A9 + A10 are relegated to B Division for next ECC The last team from A-Division to qualify plays winner B1 in World Challenge - best of three games
B Division Women 10 Teams A9 + A10 + B3 - B8 + C1 + C2 Rankings taken from the previous ECC	One Group: Round robin + Tie-breakers (one session) if required to determine top 4 teams + Play-offs	Olympic play-off system with top four teams as shown in the chart on page 64	Teams ranked B1- B10 as per WCF ranking procedure. B1 + B2 are promoted to A Division for next ECC B9+B10 are relegated to C Division Winner B1 plays the last team from A-Division to qualify in World Challenge - best of three games
B Division Men 16 teams A9 + A10 + B3 - B14 + C1 + C2 Rankings taken from the previous ECC	Two Groups of 8 teams: Group round robins + Tie-breakers (one session) if required to determine top 3 teams + Play-offs	1 st ranked teams advance directly to the semi-finals; 2A v B3 and 3A v B2 to determine last teams in semi-finals. For the semi-finals: If 2 teams from each group then 1A plays the B qualifier and 1B plays the A qualifier. If 3 teams from one group then the 1 st ranked team of that group plays the 3 rd ranked team from the same group, and the 1 st ranked team of the other group plays the 2 nd ranked team from the group that qualified 3 teams. The relegation for the ECC	Teams ranked B1- B16 as per WCF ranking procedure. B1 + B2 are promoted to A Division for next ECC B15 + B16 are relegated to C Division Winner B1 plays the last team from A-Division to qualify in World Challenge - best of three games

		B-Division men is determined in the following manner: MA7 v MB7 - winner is not relegated and MA8 v MB8 - loser is relegated Loser (MA7 v MB7) v winner (MA8 v MB8) - winner is not relegated, loser is relegated There is no tie-breaker game(s) before those relegation games and the ranking is solely done by the results of the round robin.	
C Division Men B15+B16+ other entries C Division Women B9+B10+ other entries	ONE Group if 11 or less teams and TWO groups if more than 12 teams. Group round robin + Tie-breakers if required + Play-offs	Ranking determined for 1st to 4th place, using one session of tie-breakers if necessary. 1 v 2 winner gold medal and qualifies for ECC “B”; and 3 v 4 game. Loser 1 v 2 plays winner 3 v 4, winner silver medal and qualifies for ECC “B”, loser bronze medal.	Teams ranked as per WCF ranking procedure. C1 + C2 are promoted to B-Division for next ECC

CHALLENGE EVENT

The 2nd ranked Americas Zone Association from the previous WCC, provided they are not hosting the next Championship, will be subject to any “challenges” that might come from other Associations in the Americas Zone.

If the 2nd ranked Association is hosting the next Championship, then the other Americas Zone Association from the previous Championship will be subject to any “challenges” which might come from other Associations in the Americas Zone.

The Challenge Event will have the following criteria:

1. The Association that is subject to the challenge will be determined at the conclusion of each WCC based upon the final rankings, and also considering which Association has been awarded the right to host the next WCC.
2. Other Associations in the Americas Zone that wish to challenge for a place in the WCC must submit a registration form to the WCF Secretariat by the deadline date of 31 July of the year preceding the next WCC. By the same date the Association that is subject to the challenge must also submit a registration form to the WCF Secretariat to show they are willing to host and participate in the challenge event. The registration forms will be sent by the WCF to the Americas Zone Associations prior to 1 May.
3. If there is only one Association that registered by the deadline date, then that Association is automatically qualified for the next WCC. If no teams register, the vacant spot will be given to the European or Pacific Zone in a manner determined by the WCF Executive Board.

4. The Association that is being challenged will host the challenge event. The venue and the dates of the event must be approved by the WCF prior to 31 October of the year preceding the next WCC.
5. The challenge event must be played during the month of January preceding the next WCC, unless another suitable date is agreed between the WCF, host and challengers.
6. Any Association that must host more than one challenge is not required to have those challenges at the same venue and same dates.
7. The Chief Umpire and Chief Ice Technician are appointed by the Host Association, subject to the approval of the WCF. The Host Association is responsible for their expenses.
8. Each Association involved in a WCC challenge is responsible for the Per Diem and accommodation expenses for its own teams and officials.
9. The WCF will not reimburse any travel expenses for the WCC challenge.

Playing System:

Two teams registered - a “best-of-five” series

Day One - Team Meeting + Official Training + 1 game

Day Two - 2 games

Day Three - 2 games (if required)

Three teams registered - a “double round robin”

Day One - Team Meeting + Official Training + Games 1 v 2 and 1 v 3

Day Two - Games 2 v 3 and 1 v 2 and 1 v 3

Day Three - Game 2 v 3 and Tie-breakers (if required)

Four teams registered - a “double round robin”

Day One - Team Meeting + Official Training + Draws 1 and 2

Day Two - Draws 3 and 4 and 5

Day Three - Draw 6 and Tie-breakers (if required)

Five or six teams registered - a “single round robin” and a 1 v 2 play-off

Day One - Team Meeting + Official Training + Draws 1 and 2

Day Two - Draws 3 and 4 and 5

Day Three - Tie-breakers (if required) and the 1 v 2 play-off

Time table:

- Conclusion of WCCs - challenged Associations declared
- 1 May - prior to this date registration forms sent out by WCF Secretariat
- 31 July - deadline date for registration (forms returned to the WCF Secretariat)
- 31 October - prior to this date the hosting venue and dates approved by WCF
- January (or agreed date) - the Challenge

MINIMUM STANDARDS

Required by Member Associations for Entry into World Curling Championships

1. **Curling Season:** A minimum of three months.
2. **Standard of Play:** The World Curling Federation may judge if the standard of play of a Member Association is adequate to enter the World Curling Championships.
3. **Qualification:** No Member Association, whose Annual Subscription and arrears to the World Curling Federation are not paid by 1 September of any year, is eligible to enter the World Curling Championships the following year.

ELIGIBILITY

1. Athletes are a national of the country they are representing - their residence can be anywhere.
or
Athletes are a resident of the country they are representing for a period of at least two consecutive years immediately prior to the start of the competition.
2. If an athlete has represented a country in any WCF competition, or played in an international qualifier for a WCF competition, that athlete may not represent another country in any WCF competition or WCF international qualifier until the athlete fulfills one of the above criteria **AND** a period of two consecutive years has elapsed.
3. This eligibility does not apply to competing in the Olympic / Paralympic Winter Games, which are governed by the regulations of the International Olympic / Paralympic Committee.

4. The WCF Executive Board shall resolve any dispute relating to the determination of the WCF Member Association that an athlete may represent in a WCF competition.

TIE-BREAKERS FOR FOUR QUALIFIERS

RANKING												GAMES	Number of Games	
1	2	3	4	5	6	7	8	9	10	11	12			
QX	QX	QX	X	X									4 v 5; winner + QXs ranked by head-to-head and if necessary DSC in the round robin; loser 5th	1
QX	QX	X	X	X	X								3 v 6 + 4 v 5; winners + QXs and losers ranked by head-to-head and if necessary DSC in the round robin	2
QX	X	X	X	X	X	X							2 v 7 + 3 v 6 + 4 v 5; winners + QX and losers ranked by head-to-head and if necessary DSC in the round robin	3
X	X	X	X	X	X	X	X						1 v 8 + 2 v 7 + 3 v 6 + 4 v 5; winners and losers ranked by head-to-head and if necessary DSC in the round robin	4
X	X	X	X	X	X	X	X	XE					1 v 8 + 2 v 7 + 3 v 6 + 4 v 5; 9 th eliminated and ranked 9th; winners and losers ranked by head-to-head and if necessary DSC in the round robin	4
X	X	X	X	X	X	X	X	XE	XE				1 v 8 + 2 v 7 + 3 v 6 + 4 v 5; 9 th and 10 th eliminated and ranked 9th and 10th by head-to-head; winners and losers ranked by head-to-head and if necessary DSC in round robin	4
X	X	X	X	X	X	X	X	XE	XE	XE			1 v 8 + 2 v 7 + 3 v 6 + 4 v 5; 9 th , 10 th and 11 th eliminated and ranked 9th, 10th and 11th by head-to-head and if necessary DSC; winners and losers ranked by head-to-head and if necessary DSC in round robin	4
Q	QX	QX	X	X									4 v 5; winner + QXs ranked by head-to-head and if necessary DSC in the round robin; loser 5th	1
Q	QX	X	X	X	X								3 v 6 + 4 v 5; winners + QX and losers ranked by head-to-head and if necessary DSC in the round robin	2
Q	X	X	X	X	X	X							2 v 7 + 3 v 6 + 4 v 5; winners and losers ranked by head-to-head and if necessary DSC in the round robin	3
Q	X	X	X	X	X	X	XE						2 v 7 + 3 v 6 + 4 v 5; winners and losers ranked by head-to-	3

RANKING												GAMES	Number of Games
1	2	3	4	5	6	7	8	9	10	11	12		
												head and if necessary DSC in the round robin; 8 th eliminated and ranked 8th	
Q	X	X	X	X	X	X	XE	XE				2 v 7 + 3 v 6 + 4 v 5; 8 th and 9 th eliminated and ranked 8th and 9th by head-to-head; winners and losers ranked by head-to-head and if necessary DSC in the round robin	3
Q	X	X	X	X	X	X	XE	XE	XE			2 v 7 + 3 v 6 + 4 v 5; 8 th , 9 th and 10 th eliminated and ranked 8th, 9th and 10th by head-to-head and if necessary DSC; winners and losers ranked by head-to-head and if necessary DSC in the round robin	3
Q	X	X	X	X	X	X	XE	XE	XE	XE		2 v 7 + 3 v 6 + 4 v 5; 8 th , 9 th , 10 th and 11 th eliminated and ranked 8th, 9th, 10th and 11th by head-to-head and if necessary DSC; winners and losers ranked according to head-to-head and if necessary DSC in round robin	3
Q	X	X	X	X	X	X	XE	XE	XE	XE	XE	2 v 7 + 3 v 6 + 4 v 5; 8 th , 9 th , 10 th , 11 th and 12 th eliminated and ranked 8th, 9th, 10th, 11th and 12th by head-to-head and if necessary DSC; winners and losers ranked by head-to-head and if necessary DSC in the round robin	3
Q	Q	QX	X	X								4 v 5; winner + QX ranked by head-to-head in the round robin; loser 5th	1
Q	Q	X	X	X	X							3 v 6 + 4 v 5; winners and losers ranked by head-to-head in the round robin	2
Q	Q	X	X	X	X	XE						3 v 6 + 4 v 5; winners and losers ranked by head-to-head in the round robin; 7 th eliminated and ranked 7th	2
Q	Q	X	X	X	X	XE	XE					3 v 6 + 4 v 5; winners and losers ranked by head-to-head in the round robin; 7 th and 8 th eliminated and ranked 7th and 8th by head-to-head	2
Q	Q	X	X	X	X	XE	XE	XE				3 v 6 + 4 v 5; winners and losers ranked by head-to-head in the round robin; 7 th , 8 th and 9 th eliminated and ranked 7th, 8th and 9th by head-to-head and if necessary DSC in the round robin	2

RANKING												GAMES	Number of Games
1	2	3	4	5	6	7	8	9	10	11	12		
Q	Q	X	X	X	X	XE	XE	XE	XE			3 v 6 + 4 v 5; winners and losers ranked by head-to-head in the round robin; 7 th , 8 th , 9 th and 10 th eliminated and ranked 7th, 8th, 9th and 10th by head-to-head and if necessary DSC in the round robin	2
Q	Q	X	X	X	X	XE	XE	XE	XE	XE		3 v 6 + 4 v 5; winners and losers ranked by head-to-head in the round robin; 7 th , 8 th , 9 th , 10 th and 11 th eliminated and ranked 7th, 8th, 9th, 10th and 11th by head-to-head and if necessary DSC in round robin	2
Q	Q	X	X	X	X	XE	XE	XE	XE	XE	XE	3 v 6 + 4 v 5; winners and losers ranked by head-to-head in the round robin; 7 th , 8 th , 9 th , 10 th , 11 th and 12 th eliminated and ranked 7th, 8th, 9th, 10th, 11th and 12th by head-to-head and if necessary DSC in the round robin	2
Q	Q	Q	X	X								4 v 5; winner 4th; loser 5th	1
Q	Q	Q	X	X	XE							4 v 5; winner 4th; loser 5th; 6 th eliminated and ranked 6th	1
Q	Q	Q	X	X	XE	XE						4 v 5; winner 4th; loser 5th; 6 th and 7 th eliminated and ranked 6th and 7th by head-to-head	1
Q	Q	Q	X	X	XE	XE	XE					4 v 5; winner 4th; loser 5th; 6 th , 7 th and 8 th eliminated and ranked 6th, 7th and 8th by head-to-head and if necessary DSC in the round robin	1
Q	Q	Q	X	X	XE	XE	XE	XE				4 v 5; winner 4th; loser 5th; 6 th , 7 th , 8 th and 9 th eliminated and ranked 6th, 7th, 8th and 9th by head-to-head and if necessary DSC in the round robin	1
Q	Q	Q	X	X	XE	XE	XE	XE	XE			4 v 5; winner 4th; loser 5th; 6 th , 7 th , 8 th , 9 th and 10 th eliminated and ranked 6th, 7th, 8th, 9th and 10th by head-to-head and if necessary DSC in round robin	1
Q	Q	Q	X	X	XE	XE	XE	XE	XE	XE		4 v 5; winner 4th; loser 5th; 6 th , 7 th , 8 th , 9 th , 10 th and 11 th eliminated and ranked 6th, 7th, 8th, 9th, 10th and 11th by head-to-head and if necessary DSC in the round robin	1
Q	Q	Q	X	X	XE	XE	XE	XE	XE	XE	XE	4 v 5; winner 4th; loser 5th; 6 th , 7 th , 8 th , 9 th , 10 th , 11 th and 12 th eliminated and ranked 6th, 7th, 8th, 9th, 10th, 11th and 12th by	1

RANKING												GAMES	Number of Games
1	2	3	4	5	6	7	8	9	10	11	12		
												head-to-head and if necessary DSC in the round robin	

Q = Qualified

QX = Tied but qualified

X = Tied – Tie-breaker games

XE = Tied but eliminated

TIE - BREAKERS FOR RELEGATION

RANKING												GAMES	Number of Games
1	2	3	4	5	6	7	8	9	10				
							X	X				8 v 9; winner 8th; loser 9th	1
						XT	X	X				7 through by ranking; 8 v 9 with loser relegated (9th), final ranking of 7 and winner to be determined by head-to-head in the round robin	1
					XT	XT	X	X				6 and 7 through by ranking; 8 v 9 with loser relegated (9th); final ranking of 6, 7 and winner by head-to-head and if necessary DSC in round robin	1
				XT	XT	XT	X	X				5, 6 and 7 through by ranking; 8 v 9 with loser relegated (9th); final ranking of 5, 6, 7 and winner by head-to-head and if necessary DSC in round robin	1
							X	X	XR			8 v 9; loser relegated (9th)	1
						X	X	X	X			7 v 10 and 8 v 9 with losers relegated, final ranking of winners and losers by head-to-head in the round robin	2
					XT	X	X	X	X			6 through by ranking; 7 v 10 and 8 v 9 with losers relegated and ranked by head-to-head in round robin; final ranking of 6 and winners by head-to-head and if necessary DSC in the round robin	2
				XT	XT	X	X	X	X			5 and 6 through by ranking; 7 v 10 and 8 v 9 with losers relegated and ranked by head-to-head in round robin; final ranking of 5, 6 and winners by head-to-head and if necessary DSC in the round robin	2

X = Tied – Tie-breaker Game

XT = Tied but through

XR = Tied but relegated

TIE-BREAKERS FOR QUALIFIERS AND RELEGATION

RANKING										Number of Games	
1	2	3	4	5	6	7	8	9	10		
			X	X	XN	XN	X	X		4 v 5 (winner Q 4th); loser and 6 and 7 do not qualify nor are relegated, they are ranked with the winner of the following game by head-to-head and if necessary DSC in the round robin, 8 v 9 with loser relegated (9th)	2
		X	X	X	X	XN	X	X		3 v 6 and 4 v 5 with winners ranked by head-to-head in round robin; losers plus 7 do not qualify nor are relegated, they are ranked with the winner of the following game by head-to-head and if necessary DSC in the round robin; 8 v 9 with loser relegated (9th)	3
	X	X	X	X	X	X	X	X		2 v 7 and 3 v 6 and 4 v 5 with winners ranked by head-to-head and if necessary DSC in the round robin; losers do not qualify nor are relegated, they will be ranked with the winner of the following game by head-to-head and if necessary DSC in the round robin; 8 v 9 with loser relegated (9th)	4
X	X	X	X	X	X	X	X	XR		1 v 8 and 2 v 7 and 3 v 6 and 4 v 5 with winners and losers ranked according to head-to-head and if necessary DSC in round robin; 9 th relegated by ranking (9th)	4
			X	X	XN	X	X	X	X	4 v 5 (winner Q 4th); loser plus 6 do not qualify nor are relegated they will be ranked with the winners of the following games by head-to-head and if necessary DSC in the round robin; 7 v 10 and 8 v 9 with losers relegated and ranked according to head-to-head in the round robin	3
		X	X	X	X	X	X	X	X	3 v 6 and 4 v 5 with winners ranked by head-to-head in round robin; losers do not qualify nor are relegated, they will be ranked with the winner of the following games by head-to-head and if necessary DSC in the round robin; 7 v 10 and 8 v 9 with losers relegated and ranked according to head-to-head in round robin	4
	X	X	X	X	X	X	X	X	XR	2 v 7 and 3 v 6 and 4 v 5 with winners ranked by head-to-head and if necessary DSC in the round robin;	4

RANKING										Number of Games	
1	2	3	4	5	6	7	8	9	10		
										losers do not qualify nor are relegated, they will be ranked with the winner of the following game by head-to-head and if necessary DSC in round robin; 8 v 9 with the loser relegated (9th)	

X = Tied - Tie-breaker Games XN = Tied; not qualified or relegated (no TB game)

XR = Tied but relegated

PLAY-OFF SYSTEMS

OLYMPIC PLAY-OFF SYSTEM

SEMI-FINALS

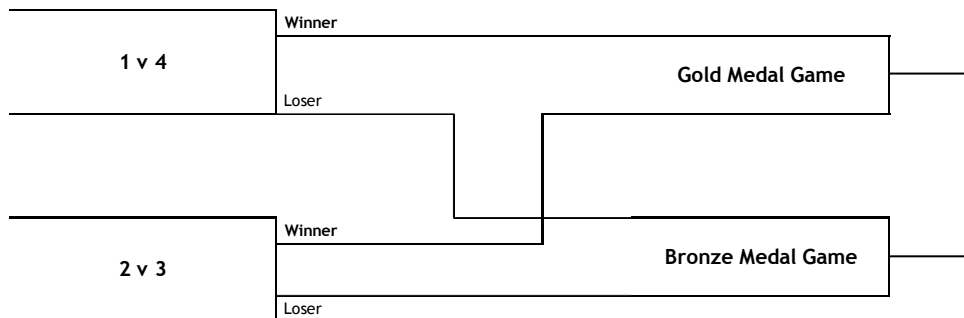

PAGE PLAY-OFF SYSTEM

PLAY-OFFS

SEMI-FINAL

FINALS

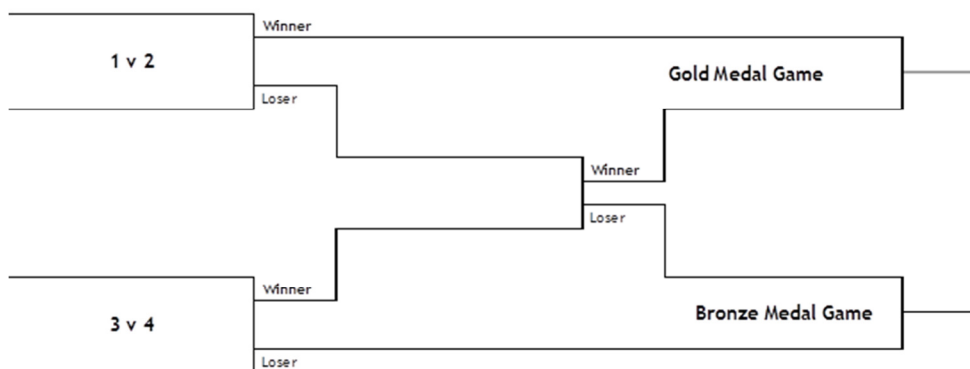

QUARTER-FINALS PLAY-OFF SYSTEM

QUALIFICATION GAME (if required)

QUARTER-FINALS

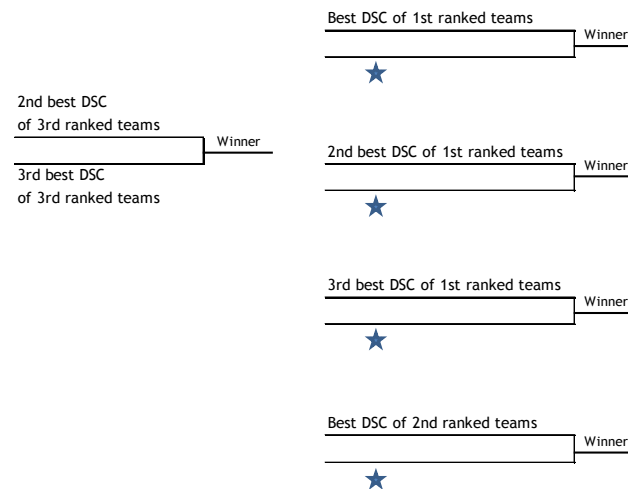

SEMI-FINALS

FINALS

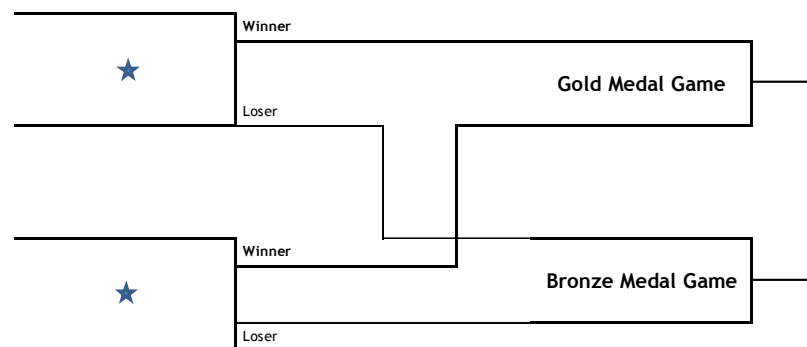

★ Where possible, opponents will be selected on the basis of not having teams from the same group compete against each other. If necessary, the opponents will be determined by a "draw from the hat" (random selection) at the post round robin team meeting.

DRESS CODE

Items	Policy
Shoes	No restrictions, personal preference
Socks	If worn under the trousers, no restrictions
Leg Warmers	Includes socks worn over the trousers, same for the complete team
Trousers	Same logos/crests/colour, can be different brands
Belts	If showing, all the same
Skirts	Matching colour, same colour of tights, can be a team mixture of skirts and trousers
Undershirts	Can be visible (long sleeves under short sleeves) but outfit must have colour coordination
Shirts	Can be tucked in or out
Vests	Okay, must have colour coordination (name, Association, etc.), one or more can wear
Jackets	As per WCF guidelines, Association, player's name, etc.
Two-tone Jackets	Predominately one colour, but can have an accent colour
Hooded Jackets	Hood cannot be showing, rolled up or tucked inside
Hats	One or more can wear, more than 1 all the same, peaks forward, logos = Association or the Event. Applies to the team and persons on the coach bench
Scarves	One or more can wear, more than 1 all the same
Head & Wrist Bands	One or more can wear, more than 1 all the same, large logos = Association or the Event
Jewellery	No restrictions, personal preference
Gloves	No restrictions, personal preference
Braces	Cannot be visible, worn under a shirt or jacket
Crests	No previous event crests are allowed Approval of sponsor crests has to be sought or renewed for each event

GLOSSARY OF TERMS

Alternate	A registered, non-playing member of the team who is eligible to substitute for one of the competing players.
Away End	The end of the sheet to which the first stone of a game is delivered.
Back Board / Bumper	Material (e.g. foam or wood) placed at the end (perimeter) of each sheet of ice.
Back House Weight	The speed given to a stone at delivery so that it will just reach the back of the house.
Back Line	A line at the back of the house, extending across the width of the sheet, which is parallel to and located 1.829 m. (6 ft.) from each tee line.
Back of the House	The area within the house that lies between the tee line and the back line.
Biter	A stone that just touches the outer edge of the outside circle of the house.
Blank End	An end resulting in no score for either team.
Bonspiel	A curling competition or tournament.
Brush (Broom)	A device used by players to sweep/clean the ice in front of a moving stone.
Button	The small circle at the centre of the house.
Burned Stone	A stone in motion touched by a player or any part of a player's equipment.
Centre Line	The line dividing the playing surface down the middle. It joins the midpoints of the tee lines and extends 3.658 m. (12 ft.) beyond the centre of each tee line.
Circles	See definition: House.
Competition	Any number of teams playing games to determine a winner.
Come Around	A shot that curls behind another stone.
Counter	Any stone in or touching the house and is considered a potential point.
Courtesy Line	A line indicating where the sweepers from the non-delivering team are allowed to stand in order to ensure that an umpire can view the hog line and to prevent distraction of a delivering player.
Curl	The curved path of a stone as it travels down the sheet of ice.
Delivery End	The end of the sheet from which the stones are being delivered.
Delivering Team	The team that is currently in control of the playing area, and scheduled to deliver the next stone.
Delivery	The motion a player makes when playing a curling stone.

Delivery Stick	A device that attaches to the handle of the stone and acts as an extension of the arm/hand during the delivery process.
Displaced Stone	A stationary stone that has been moved to a new location.
Divider	Material (e.g. foam or wood) used to separate the sheets of curling ice.
Double Take-out	A stone that removes two of the opponent's stones from play.
Draw	A stone which stops inside or in front of the house.
Draw Shot Challenge (DSC)	The calculation made by taking the average distance of the Last Stone Draws (LSD), excluding the least favourable LSD(s), and used, if required, to assist in the determination of ranking after a round robin.
Draw Weight	The momentum required for a delivered stone to reach the house at the playing end.
Electronic Hog Line Device	A device that indicated if a stone was released by a player before the stone reached the hog line at the delivery end.
End	A portion of a curling game that is completed when each team has thrown eight stones and/or the score has been decided.
Equipment	Anything that is worn or carried by a player.
Extra End	An additional end played to break a tie at the end of regulation play.
External Force	An occurrence not caused by either team.
First Player	The first curler on a team to deliver two stones in each end.
Fourth Player	The fourth curler on a team to deliver two stones in each end.
Free Guard Zone (FGZ)	The area at the playing end, between the hog line and the tee line, but excluding the house.
Freeze	A form of a draw shot that stops directly up against another stone.
Front House Weight	The momentum required for a delivered stone to reach the front part of the house at the playing end.
Forfeit	If a team cannot start or continue a game the other team will win that game. The final game score will be recorded as W-L.
Game	Two teams playing a specified number of ends to determine a winner.
Guard	A stone that is placed in a position so that it may protect another stone.
Hack	The foot-hold at each end of the ice which is used by players (except wheelchair curlers) to start the delivery of a curling stone.
Hack Line	A small line 0.457 m. (1 ft. 6 in.) parallel to the tee line, at each end of the centre line.
Hack Weight	The momentum required for a delivered stone to reach the hack at the playing end.
Handle	The part of a curling stone that a player grips in order to deliver.

Hammer	A term used to describe the stone that will be the last stone delivered in that end.
Heavy	A stone delivered with a greater speed than necessary.
Hit	A take-out. Removal of a stone from the playing area by hitting it with another stone.
Hit and Roll	A stone that knocks an opponent's stone out of play, and then rolls to another position in play.
Hog Line	A line extending across the width of the sheet that is parallel to and located 6.40 m. (21 ft.) from each tee line.
Hog Line Violation	A stone that is removed from play for the end, because it was not released before it reached the hog line at the delivery end.
Hogged Stone	A stone that is removed from play for the end, because after being delivered, it did not come to rest completely beyond the inside edge of the hog line at the playing end.
Home End	The end of the sheet from which the first stone of a game is delivered.
House	The area within the concentric circles at each end of the sheet.
Hurry	A command, which instructs players to sweep harder.
Ice Surface	The complete ice area that is within the perimeters of the curling sheet.
In the Process of Delivery	The sequence of play that begins when the delivering player is in position to start the delivery and concludes when the stone is released.
In-turn	The rotation applied to the handle of a stone by a right-handed curler, which causes the stone to rotate in a clockwise manner.
Last Stone Draw (LSD)	A contest conducted at the conclusion of a team's pre-game practice in which each team delivers two stones by different players, the first stone with a clockwise and the second with a counter-clockwise rotation, to the tee at the home end. The resulting distances are measured and used to determine which team has the choice of delivering the first or second stone in the first end.
Lead	The first player on a team to deliver two stones in each end.
Mathematically Eliminated	The status of a team that has a combined total of stones left to be delivered and/or remaining in play that is less than the number needed to produce either a tie or a win.
Measuring Device	An instrument that determines which stone is closer to the centre of the house (Tee), or whether a stone is in the house.
Moving Stone	A stone in motion either from a delivery or from being struck by another stone.
Original Position of a Stone	The location on the ice where a stone rested prior to its being displaced.

Out-of-play Position	The location of a stone that is not in play (e.g. one which has touched a side line, or crossed the back line).
Out-turn	The rotation applied to the handle of a stone by a right-handed curler, which causes the stone to rotate in a counter-clockwise manner.
Pebble	The water droplets applied to a sheet of ice before commencing play. These droplets freeze, which then reduces the friction between the ice and the stones.
Peel	A shot designed to remove a guard.
Playing End	The end of the sheet to which the stones are being delivered.
Point	At the completion of an end, one is awarded to a team for each of its own stones located in or touching the house that is closer to the tee than any stone of the opposition.
Port	An opening, or gap, between stones.
Positioned Stones	In Mixed Doubles games, the two stones that are placed in designated positions prior to the start of each end.
Raise	A type of draw which bumps forward another stone.
Raise Take-out	A delivered stone hits a stationary stone, which then starts to move and it hits a third stone out of play.
Rings	See definition: House.
Rock	See definition: Stone.
Roll	The sideways movement of a curling stone after it has struck a stationary stone.
Rotation	The direction of turn of a stone (clockwise or counter-clockwise).
Round Robin	A competition in which each team plays all the other teams.
Score	The number of points received by a team in an end.
Scoring	A team scores one point for each of its stones that is within the house and closer to the tee than any stone of the opposing team.
Second Player	The second curler on a team to deliver two stones in each end.
Sheet	The specific ice surface upon which a curling game is played.
Shot (stone or rock)	At any time during an end, the stone closest to the tee.
Side Line	A line placed at the side (perimeter) of each sheet of ice.
Skip	The player who directs play for the team.
Slider	Slippery material placed on the sole of the sliding shoe, which makes it easier to slide on the ice.
Spare	See definition: Alternate.
Stationary Stone	A stone in play which is not in motion.
Stone	Also known as a rock, a curling stone is made of granite and is delivered by the players in a curling game.

Stone Set in Motion	A stationary stone hit by another stone which causes it to move.
Sweeping	The action of moving a broom or brush back and forth in front of the path of a moving stone to clean or polish the ice surface.
Swingy Ice	The condition of the ice or stones causing the stones to have excessive curl.
Take-out	Removal of a stone from the playing area by hitting it with another stone.
Team	Four players competing together. A team may include a fifth player (to act as an alternate) and a coach. Mixed Doubles have one male and one female player, and may include a coach.
Team Time-out	A 60 second on-ice meeting between a team and their coach.
Technical Time-out	Stoppage of play called by a team or umpire for a ruling, injury, or in other extenuating circumstances etc.
Tee	The exact centre of the house.
Tee Line	A line extending across the width of the sheet that passes through the centre of the house parallel to the hog line and backline.
Third Player	The third curler on a team to deliver two stones in each end.
Tie-breaker	A game that is played to break a tied ranking at the end of the round robin, so that the correct number of teams is determined for the play-offs, challenge and relegation positions.
Top of the House	The area within the house that lies between the hog line and the tee line.
Umpire	The person(s) responsible for the conduct of the game in accordance with the rules.
Vice-Skip (Mate or Acting Skip)	The player who directs play for the team when it is the skip's turn to deliver.
Weight	The amount of force/speed given to the stone during the delivery.
Wheelchair Lines	Two lines that run from the hog line to the outermost edge of the nearest circle of the house. Wheelchair curlers are allowed to start their delivery with the stone placed between these lines.